

NOVELTIES / NOVEDADES

# COSMIC

2023

CATALOGUE  
CATÁLOGO





# COSMIC





Stimulation, relaxation, comfort...  
the bathroom reintroduces us to  
ourselves through objects that  
transcend the merely functional.

---

Activarse, relajarse, sentirse cómodo...  
en el baño nos reencontramos con  
nosotros mismos, a través de una  
serie de objetos que trascienden lo  
meramente funcional.



# Bath Experiences

- 006 COSMIC
- 008 COSMIC AROUND THE WORLD  
COSMIC EN EL MUNDO
- 010 THE CREATORS  
LOS CREADORES
- 012 SHOWROOM
- 014 INDEX OF FIXINGS  
ÍNDICE DE FIJACIONES
- 016 INDEX OF FINISHES  
AND MATERIALS  
ÍNDICE DE ACABADOS  
Y MATERIALES
- 018 INDEX OF REFERENCES  
PVP / €  
ÍNDICE DE REFERENCIAS  
PVP / €
-  022 ACCESSORIES  
ACCESORIOS
- NEW FINISHES** 022 **Architect S**
- 034 **Next**
- 042 **Start**
-  050 FREE STANDING ACCESSORIES  
COMPLEMENTOS
- 050 **L'Avenir**
-  058 ESSENTIALS  
058 **Magnifying mirror**  
**Espejo aumento**
-  062 FURNITURE WITH WASHBASIN  
AND MIRRORS  
MOBILIARIO CON LAVABO  
Y ESPEJOS
- 062 **Lagoon**
-  086 FAUCETS AND SHOWERS  
GRIFERÍA Y DUCHAS
- 086 **Architect**
- 094 SPARE PARTS  
RECAMBIOS
- 096 MATERIALS  
MATERIALES
- 100 SALES CONDITIONS  
CONDICIONES DE VENTA

FOR ALL NEW PRODUCTS, PLEASE REQUEST US THE LAUNCH DATES.  
PARA TODOS LOS NUEVOS PRODUCTOS, POR FAVOR CONSULTARNOS LAS FECHAS DE LANZAMIENTO.





# Cosmic

We create design environments for bathrooms. We transform spaces into pleasant places with aesthetic functionality. A nonconformist and visionary personality that leads us to the constant search for innovation focused on the customer: To enhance and offer an expressive and quality product in order to exhort to renovate, complete and decorate the bathroom.

---

Creamos ambientes de diseño para el baño. Transformamos espacios en lugares armoniosos con funcionalidad estética. Una personalidad inconformista y soñadora que nos posiciona en la innovación constante enfocada al cliente: Destacar, ofrecer un producto con expresión y valor que invite a renovar, completar y decorar el cuarto de baño.



# Cosmic around the world

## Cosmic en el mundo



## COSMIC



2 production centers.  
2 centros de producción.

**1985**

Created in 1985 as a manufacturer of bathroom accessories.

Creada en 1985 como fabricante de accesorios de baño.

**2008**

In 2008, strategic alliance with Roca to combine synergies and become global business leaders of furniture, bathroom accessories and shower enclosures.

En 2008, alianza estratégica con Roca para aunar sinergias y convertirse en líderes mundiales de negocio de mobiliario, accesorios de baño y mamparas de ducha.

**2009**

In 2009, Pomd'or (Blanch Cristal) is assumed by Industrias Cosmic S.A. in order to position this brand as a reference of luxury and elegance.

En 2009, Pomd'or (Blanch Cristal) es asumida por Industrias Cosmic S.A. para posicionar esta marca como referente de lujo y elegancia.

**2010**

In 2010, through the acquisition of Stildux we incorporate the division of shower enclosures.

En 2010, mediante la adquisición de Stildux se incorpora la división de mamparas de ducha.







COSMIC. Bigues i Riells. Barcelona. Spain.

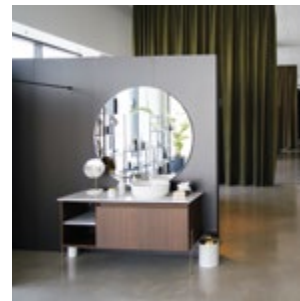

COSMIC. Gavà. Barcelona. Spain.

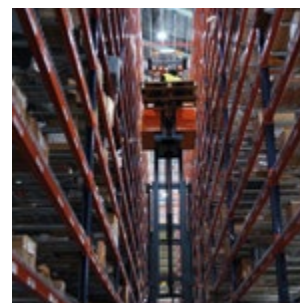

COSMIC. China.

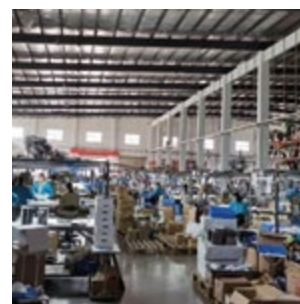

**2020**

In 2020 Cosmic became the Competence Center for bathroom Accessories for Roca Group.

En 2020 Cosmic se convierte en el Centro de Competencia de Accesorios de baño del Grupo Roca.

**2021**

In 2021 Cosmic gran opening of its new headquarters and showroom in Bigues i Riells and new warehouse in Gavà.

En 2021 Cosmic gran apertura de su nueva sede y showroom en Bigues i Riells y nuevo almacén en Gavà.

**2022**

In 2022 Cosmic migrated successfully to SAP all its business systems.

En 2022 Cosmic migra con éxito a SAP todos sus sistemas de negocio.

**2023**

In 2023 Cosmic empowered the unique brand and renewed the image, integrating all portfolios.

En 2023 Cosmic potencia la marca única y renueva la imagen, integrando todas las carteras.





Miquel de Mas



Xavier Claramunt



Carles Ferruz



Eugeni Quitllet



Martín Ruiz Azua



Ricard Ferrer



Àlex Armenter



Nahtrang



# The creators

## Los creadores

Over the years the Cosmic Studio has been designing and developing numerous collections that have become classics. It has also collaborated with and coordinated work by renowned designers.

A lo largo de la historia Cosmic Studio ha diseñado y desarrollado multitud de colecciones que se han convertido en clásicos, y ha colaborado y coordinado el trabajo de reconocidos diseñadores.



Cosmic Studio



# Showroom

Cosmic Showroom, situated at the central office of Industrias Cosmic, S.A.U., is a place to experience the contact with the product. Washbasins, bathtubs, cabinets, faucets and accessories...

Cosmic showroom es un espacio situado en la sede central de Industrias Cosmic, S.A.U. donde disfrutar de la experiencia del contacto con el producto. Lavabos, bañeras, mobiliario, griferías y accesorios...



INDUSTRIAS COSMIC  
C/ESQUEIS S/N. LOCAL 1  
POL. IND. CAN BARRI  
08415 BIGUES I RIELLS  
BARCELONA SPAIN  
T. +34 938 654 277  
info@icosmic.com  
www.icosmic.com



# Index of fixings

## Índice de fijaciones



CATALOGUE / PAGE  
CATÁLOGO / PÁGINA

NEW FINISHES

Architect

COSMIC 01 / 006



SMART  
FIX



Architect **S**

COSMIC 03 / 022



Bath life

COSMIC 01 / 048



Belle

COSMIC 01 / 060



Black & White

COSMIC 01 / 074



Diabolo

COSMIC 01 / 084



QUICK  
FIX



Duo

COSMIC 01 / 092



QUICK  
FIX



Eda

COSMIC 01 / 108



Equilibrium

COSMIC 01 / 122



Extreme

COSMIC 01 / 134



Kubic

COSMIC 01 / 144



SMART  
FIX



Kubic Class

COSMIC 01 / 160



SMART  
FIX



Kubic Cool

COSMIC 01 / 176



SMART  
FIX



Line

COSMIC 01 / 192



QUICK  
FIX



Logic

COSMIC 01 / 200



Metric

COSMIC 01 / 216



Micra

COSMIC 01 / 230



Minimalism

COSMIC 01 / 242



NEW

Next

COSMIC 03 / 034



QUICK  
FIX



Project

COSMIC 01 / 252



NEW

Start

COSMIC 03 / 042



Stick

COSMIC 01 / 264



QUICK  
FIX



The Grid

COSMIC 01 / 276



Urban

COSMIC 01 / 286



Windsor













COSMIC 01 / 298





# Index of finishes and materials

## Índice de acabados y materiales

		001 CHROME CROMO	036 MATTE BLACK NEGRO MATE	003/021 MATTE STAINLESS STEEL INOX MATE	002 GLOSSY STAINLESS STEEL INOX BRILLO	006 GLOSSY BLACK NEGRO BRILLO	065 MATTE WHITE BLANCO MATE	005 GLOSSY WHITE BLANCO BRILLO	059 WHITE GREY BLANCO GRIS	028 MATTE GREY GRIS MATE	014 CHROME GOLD CROMO ORO	004 GLOSSY GOLD ORO BRILLO
	MATERIALS MATERIALES											
	Architect	●										
NEW FINISHES	Architect S <sup>+</sup>	●	●	●			●					
	Bathlife	●										
	Belle	●										●
	Black & White		●			●	●	●				
	Diabolo	●	●				●					
	Duo	●										
	Eda	●	●									
	Equilibrium	●										●
	Extreme	●										
	Kubic	●	●									
	Line	●										
	Logic	○	●	●	●							
	Metric	●	●	●								
	Micra	●	●									
	Minimalism	●										
NEW	Next	●	●									
	Project	●										
NEW	Start	●	●									
	Stick	●	●				●					
	The Grid	●	●				●					
	Urban	●										
	Windsor	●									●	●
												
NEW	L'Avenir											
	B-Smart							●	●			
	Geyser	●	●				●					
	Inside					●		●				
	Saku		●			●	●	●		●		







# Index of references

## Índice de referencias

REFERENCES REFERENCIAS	Ⓢ	PAGE PÁGINA	REFERENCES REFERENCIAS	Ⓢ	PAGE PÁGINA
WJB269A0049001		46	WJC205G0022036		92
WJB269A0050001		46	WJC205G0023036		92
WJB341R0031000		-	WJC205G0024001		92
WJC205A0003001	Ⓢ	27	WJC205G0024036		92
WJC205A0003003		27	WJC205G0026001		92
WJC205A0003040		27	WJC215A0000001		40
WJC205A0003054		27	WJC215A0000036		40
WJC205A0003055		27	WJC215A0001001		40
WJC205A0003065		27	WJC215A0001036		40
WJC205A0004001	Ⓢ	27	WJC215A0004001		38
WJC205A0004003		27	WJC215A0004036		38
WJC205A0004036		27	WJC215A0005001		38
WJC205A0004040		27	WJC215A0005036		38
WJC205A0004054		27	WJC215A00021001		38
WJC205A0004055		27	WJC215A00021036		38
WJC205A0004065		27	WJC215A00022001		38
WJC205A0011001		31	WJC215A00022036		38
WJC205A0021001	Ⓢ	27	WJC215A00052001		38
WJC205A0021003		27	WJC215A00052036		38
WJC205A0021036		27	WJC215A00053001		38
WJC205A0021040		27	WJC215A00053036		38
WJC205A0021054		27	WJC215A00058001		40
WJC205A0021055		27	WJC215A00058036		40
WJC205A0021065		27	WJC215A00059001		40
WJC205A0051001		27	WJC215A00059036		40
WJC205A0051003		27	WJC215A00063001		39
WJC205A0051036		27	WJC215A00063036		39
WJC205A0051040		27	WJC215A00064001		39
WJC205A0051054		27	WJC215A00064036		39
WJC205A0051055		27	WJC215A00065001		39
WJC205A0051065		27	WJC215A00065036		39
WJC205A0053001		27	WJC215A00068001		39
WJC205A0053003		27	WJC215A00068036		39
WJC205A0053036		27	WJC215A00071001		39
WJC205A0053040		27	WJC215A00071036		39
WJC205A0053054		27	WJC215A00075001		39
WJC205A0053055		27	WJC215A00075036		39
WJC205A0053065		27	WJC215A00096001		40
WJC205G0001001		90	WJC215A00096036		40
WJC205G0001036		90	WJC216A0001080		57
WJC205G0002001		90	WJC216A0001081		57
WJC205G0002036		90	WJC216A0001082		57
WJC205G0004001		90	WJC216A0001083		57
WJC205G0007001		90	WJC216A0004080		57
WJC205G0007036		90	WJC216A0004081		57
WJC205G0008001		90	WJC216A0004082		57
WJC205G0008036		90	WJC216A0004083		57
WJC205G0009001		91	WJC216A00034080		57
WJC205G0009036		91	WJC216A00034081		57
WJC205G0011001		90	WJC216A00034082		57
WJC205G0012001		91	WJC216A00034083		57
WJC205G0012036		91	WJC216A00053080		57
WJC205G0014001		91	WJC216A00053081		57
WJC205G0014036		91	WJC216A00053082		57
WJC205G0015001		91	WJC216A00053083		57
WJC205G0016001		91	WJC226A0001002		49
WJC205G0018001		93	WJC226A0001036		49
WJC205G0018036		93	WJC226A0003002		47
WJC205G0021001		92	WJC226A0003036		47
WJC205G0021036		92	WJC226A0004002		47



REFERENCIAS REFERENCIAS	S	PAGE PÁGINA
WJC226A0004036		47
WJC226A0051002		47
WJC226A0051036		47
WJC226A0053002		47
WJC226A0053036		47
WJC226A0097002		49
WJC226A0097036		49
WJC235A0000001	S	29
WJC235A0000003	S	29
WJC235A0000036	S	29
WJC235A0000040		29
WJC235A0000054		29
WJC235A0000055		29
WJC235A0000065		29
WJC235A0001001	S	29
WJC235A0001003	S	29
WJC235A0001036	S	29
WJC235A0001040		29
WJC235A0001054		29
WJC235A0001055		29
WJC235A0001065		29
WJC235A0002001		32
WJC235A0002003		32
WJC235A0003001		30
WJC235A0003003		30
WJC235A0003036		30
WJC235A0021001	S	27
WJC235A0021003	S	27
WJC235A0021036	S	27
WJC235A0021040		27
WJC235A0021054		27
WJC235A0021055		27
WJC235A0021065		27
WJC235A0023001		29
WJC235A0023003		29
WJC235A0023036		29
WJC235A0024001		31
WJC235A0024003		31
WJC235A0024036	S	31
WJC235A0025001	S	31
WJC235A0025003		31
WJC235A0025036	S	31
WJC235A0028002		30
WJC235A0028003	S	30
WJC235A0028036	S	30
WJC235A0033034		30
WJC235A0040001		32, 33
WJC235A0040003		32, 33
WJC235A0040036		32, 33
WJC235A0042000		32, 33
WJC235A0044001		30
WJC235A0044003		30
WJC235A0044036		30
WJC235A0047001		30
WJC235A0047036		30
WJC235A0048001	S	29
WJC235A0048003	S	29
WJC235A0048036	S	29
WJC235A0048040		29
WJC235A0048054		29

REFERENCIAS REFERENCIAS	S	PAGE PÁGINA
WJC235A0048055		29
WJC235A0048065		29
WJC235A0049001	S	28, 33
WJC235A0049003	S	28, 33
WJC235A0049036	S	28, 33
WJC235A0049040		28, 33
WJC235A0049054		28, 33
WJC235A0049055		28, 33
WJC235A0049065		28, 33
WJC235A0053001		30
WJC235A0053003		30
WJC235A0053036		30
WJC235A0057001		32
WJC235A0057003		32
WJC235A0057036		32
WJC235A0058001	S	29
WJC235A0058003	S	29
WJC235A0058036	S	29
WJC235A0058040		29
WJC235A0058054		29
WJC235A0058055		29
WJC235A0058065		29
WJC235A0059001	S	29
WJC235A0059003	S	29
WJC235A0059036	S	29
WJC235A0059040		29
WJC235A0059054		29
WJC235A0059055		29
WJC235A0059065		29
WJC235A0060001		31
WJC235A0060003		31
WJC235A0060036		31
WJC235A0061001		31
WJC235A0061003		31
WJC235A0061036		31
WJC235A0062001		32
WJC235A0062003	S	32
WJC235A0062036	S	32
WJC235A0063001	S	28
WJC235A0063003	S	28
WJC235A0063036	S	28
WJC235A0063040		28
WJC235A0063054		28
WJC235A0063055		28
WJC235A0063065		28
WJC235A0064001	S	28
WJC235A0064003	S	28
WJC235A0064036	S	28
WJC235A0064040		28
WJC235A0064054		28
WJC235A0064055		28
WJC235A0064065		28
WJC235A0065001		31
WJC235A0065003		31
WJC235A0065036		31
WJC235A0068001		31
WJC235A0068003	S	31
WJC235A0068036	S	31
WJC235A0069001	S	28
WJC235A0069003	S	28

**REFERENCIAS**  
**REFERENCIAS**



**PAGE**  
**PÁGINA**

WJC235A0069036	28
WJC235A0069040	28
WJC235A0069054	28
WJC235A0069055	28
WJC235A0069065	28
WJC235A0071001	28
WJC235A0071003	28
WJC235A0071036	28
WJC235A0071040	28
WJC235A0071054	28
WJC235A0071055	28
WJC235A0071065	28
WJC235A0075001	31
WJC235A0075003	31
WJC235A0075036	31
WJC235A0085001	28
WJC235A0085003	28
WJC235A0085036	28
WJC235A0085040	28
WJC235A0085054	28
WJC235A0085055	28
WJC235A0085065	28
WJC235A0096001	32
WJC235A0096003	32
WJC235A0096036	32
WJC292A0002003	49
WJC292A0002036	49
WJC292A0184001	61
WJC292A0184036	61
WJC341R0387000	83
WJC341R0735000	-
WJC341R0786000	83
WJC341R0787000	83
WJC341R0789000	83
WJC341R0790000	83
WJC341R0833000	-
WJC341R0834000	-
WJC341R0835000	-
WJC341R1145000	-
WJC341R7600000	83
WJC419A0000001	49
WJC419A0000036	49
WJC419A0003036	27
WJC419A0005001	47
WJC419A0005036	47
WJC419A0011036	31
WJC419A0021001	46
WJC419A0021036	46
WJC419A0022001	46
WJC419A0022036	46
WJC419A0030001	46
WJC419A0030036	46
WJC419A0032001	46
WJC419A0032036	46
WJC419A0044001	48
WJC419A0044036	48
WJC419A0049036	46
WJC419A0050036	46
WJC419A0052001	47
WJC419A0052036	47
WJC419A0055001	49
WJC419A0055036	49
WJC419A0056001	49
WJC419A0056036	49
WJC419A0058001	48
WJC419A0058036	48

**REFERENCIAS**  
**REFERENCIAS**



**PAGE**  
**PÁGINA**

WJC419A0059001	48
WJC419A0059036	48
WJC419A0064001	48
WJC419A0064036	48
WJC419A0065001	48
WJC419A0065036	48
WJC419A0068001	48
WJC419A0068036	48
WJC419A0072001	48
WJC419A0072036	48
WJC781M0001102	76, 78
WJC781M0001116	76, 78
WJC781M0001122	76, 78
WJC781M0001126	76, 78
WJC781M0001535	76, 78
WJC781M0001766	76, 78
WJC781M0001767	76, 78
WJC781M0001768	76, 78
WJC781M0002102	76, 78
WJC781M0002116	76, 78
WJC781M0002122	76, 78
WJC781M0002126	76, 78
WJC781M0002535	76, 78
WJC781M0002766	76, 78
WJC781M0002767	76, 78
WJC781M0002768	76, 78
WJC781M0003102	76, 78
WJC781M0003116	76, 78
WJC781M0003122	76, 78
WJC781M0003126	76, 78
WJC781M0003535	76, 78
WJC781M0003766	76, 78
WJC781M0003767	76, 78
WJC781M0003768	76, 78
WJC781M0004102	76, 78
WJC781M0004116	76, 78
WJC781M0004122	76, 78
WJC781M0004126	76, 78
WJC781M0004535	76, 78
WJC781M0004766	76, 78
WJC781M0004767	76, 78
WJC781M0004768	76, 78
WJC781M0005102	76, 78
WJC781M0005116	76, 78
WJC781M0005122	76, 78
WJC781M0005126	76, 78
WJC781M0005535	76, 78
WJC781M0005766	76, 78
WJC781M0005767	76, 78
WJC781M0005768	76, 78
WJC781M0006102	76, 78
WJC781M0006116	76, 78
WJC781M0006122	76, 78
WJC781M0006126	76, 78
WJC781M0006535	76, 78
WJC781M0006766	76, 78
WJC781M0006767	76, 78
WJC781M0006768	76, 78
WJC781M0007102	79
WJC781M0007116	79
WJC781M0007122	79
WJC781M0007126	79
WJC781M0007535	79
WJC781M0007766	79
WJC781M0007767	79
WJC781M0007768	79



**REFERENCES**  
**REFERENCIAS**



**PAGE**  
**PÁGINA**

WJC781M0008102	76, 80
WJC781M0009102	76, 80
WJC781M0010102	76, 80
WJC781M0011102	76, 80
WJC781M0012102	76, 80
WJC781M0013102	76, 80
WJC781M0014102	76, 80
WJC781M0015102	76, 80
WJC781M0016102	76, 80
WJC781M0017102	76, 80
WJC781M0018766	81
WJC781M0019766	81
WJC781M0020766	81
WJC781M0021766	81
WJC781M0022766	81
WJC781M0023766	81
WJC781M0024102	77, 82
WJC781M0025102	77, 82
WJC781M0026102	77, 82
WJC781M0027102	77, 82
WJC781M0028102	77, 82
WJC781M0029102	77, 82
WJC781M0030766	82
WJC781M0031766	82
WJC781M0032766	82
WJC781M0033766	82
WJC781M0034766	82
WJC781M0035766	83
WJC781M0036102	77, 83
WJC781M0036116	77, 83
WJC781M0036122	77, 83
WJC781M0036126	77, 83
WJC781M0036535	77, 83
WJC781M0036766	77, 83
WJC781M0036767	77, 83
WJC781M0036768	77, 83
WJC781M0037102	77, 83
WJC781M0037116	77, 83
WJC781M0037122	77, 83
WJC781M0037126	77, 83
WJC781M0037535	77, 83
WJC781M0037766	77, 83
WJC781M0037767	77, 83
WJC781M0037768	77, 83
WJC781M0038102	77, 83
WJC781M0038116	77, 83
WJC781M0038122	77, 83
WJC781M0038126	77, 83
WJC781M0038535	77, 83
WJC781M0038766	77, 83
WJC781M0038767	77, 83
WJC781M0038768	77, 83
WJC781M0039102	77, 83
WJC781M0039116	77, 83
WJC781M0039122	77, 83
WJC781M0039126	77, 83
WJC781M0039535	77, 83
WJC781M0039766	77, 83
WJC781M0039767	77, 83
WJC781M0039768	77, 83
WJC781M0042102	81
WJC781M0043102	81
WJC781M0043766	81
WJC781M0043767	81
WJC781M0044102	81
WJC781M0044766	81

**REFERENCES**  
**REFERENCIAS**



**PAGE**  
**PÁGINA**

WJC781M0044767	81
WJC781M0045102	79
WJC781M0045116	79
WJC781M0045122	79
WJC781M0045535	79
WJC781M0045766	79
WJC781M0046102	79
WJC781M0046116	79
WJC781M0046122	79
WJC781M0046535	79
WJC781M0046766	79
WJC781M0047102	79
WJC781M0047116	79
WJC781M0047122	79
WJC781M0047535	79
WJC781M0047766	79
WJC781M0048102	80
WJC781M0048116	80
WJC781M0048122	80
WJC781M0048535	80
WJC781M0048766	80
WJC781M0049102	79
WJC781M0049116	79
WJC781M0049122	79
WJC781M0049535	79
WJC781M0049766	79
WJC781M0055102	83
WJC781M0056766	83
WJC781M0057102	79
WJC781M0057116	79
WJC781M0057122	79
WJC781M0057126	79
WJC781M0057535	79
WJC781M0057766	79
WJC781M0057767	79
WJC781M0057768	79
WJC781M0058102	76, 80
WJC781M0059102	77, 82
WJC781M0060000	84
WJC781M0061000	84
WJC781M0062000	84
WJC781M0063000	84
WJC781M0064000	84
WJC781M0065000	84
WJC781M0066000	84
WJC781M0067000	84
WJC781M0068102	77, 82
WJC781M0108102	-
WJC781M0109102	-
WJC781M0110102	-
WJC781M0111102	-
WJC781M0112102	-
WJC781M0113102	-
WJC781M0114102	-
WJC781M0115102	-
WJC781M0116102	-
WJC781M0117102	-
WJC781M0118766	-
WJC781M0119766	-
WJC781M0120766	-
WJC781M0121766	-
WJC781M0122766	-
WJC781M0123766	-
WJC781M0158102	-

# Architect



Design by **Cosmic Studio**





**Go to the next level**





## New finishes Nuevos acabados

This makes for a total of seven finishes, including three brushed PVD finishes. PVD is one of the most revolutionary treatments in recent years thanks to the variety of colours available and its lasting results, which offer improved resistance to abrasion, scratching and corrosion.

Un total de 7 acabados, entre ellos 3 acabados cepillados en PVD. El PVD es uno de los tratamientos más revolucionarios en los últimos tiempos gracias a la variedad de colores que ofrece y a sus resultados más duraderos con una mayor resistencia a la abrasión, a las ralladuras y a la corrosión.

**Chrome** is a must in any catalogue and is the quintessential finish in the world of accessories. It offers durability, protects against corrosion, facilitates the cleaning process and boasts great versatility, allowing designers to create more varied, original designs.

El **chromo** como un "must" en cualquier catálogo, es el acabado por excelencia en el mundo del accesorio. Aporta durabilidad, protege contra la corrosión, facilita el proceso de limpieza y ofrece una gran versatilidad permitiendo crear diseños más variados y originales.



**001**  
CHROME  
CROMO



**036**  
BLACK MATT  
NEGRO MATE



**065**  
MATT WHITE  
BLANCO MATE

**Matte finishes** offer an alternative that is particularly on-trend in the interior design industry, providing parts with a resistant, lasting finish with a pleasing feel.

Los **acabados mate**, ofrecen una alternativa muy en tendencia en el sector del interiorismo proporcionando a las piezas un acabado resistente, duradero, y muy agradable al tacto.



## Accessories | Accesorios

Cosmic is reviving one of the classics with an improved version of the **brushed stainless steel** finish that was very popular among advisors. With a smooth, uniform brushing technique, this innovation comes to life on a classic finish.

Cosmic revive uno de los clásicos con una versión mejorada del acabado **inox cepillado**, muy popular entre prescriptores. Con un cepillado suave y uniforme, es innovación sobre un acabado clásico.



**003**  
BRUSHED STEEL  
INOX CEPILLADO



**054**  
BRUSHED COPPER PVD  
COBRE CEPILLADO PVD



**040**  
BRUSHED GOLD PVD  
ORO CEPILLADO PVD



**055**  
BRUSHED BLACK PVD  
NEGRO CEPILLADO PVD

**NEW**

**PVD** is an environmentally friendly technology through which stainless steel and titanium are linked at a molecular level to form a superficial metal alloy. Via electrolysis, the metal powder penetrates the previously treated materials' pores, becoming part of the object's composition itself, thus increasing its durability and providing much lighter coatings.

EL **PVD** es una tecnología respetuosa con el medio ambiente mediante el cual el acero inoxidable y el titanio se ligan a nivel molecular formando una aleación metálica superficial. A través de la electrólisis, el polvo de metales penetra en los poros de los materiales, previamente tratados, pasando a formar parte de la propia composición del objeto, aumentando la durabilidad y aportando recubrimientos mucho más ligeros.





## More versatile Más versátil

Cosmic is growing one of its most comprehensive collections, **Architect S+**, with more than 25 different accessories designed to offer optimal functionality, adding four new finishes to its range to allow it to fit in with any style of bathroom. The new offering stands out by including a wide selection of finishes in many of its parts, turning the **Architect S+** collection into a range that is a safe bet, superior, sustainable, decisive and now more versatile than ever. Because **Cosmic is Innovation's Mind**.

Cosmic hace crecer una de sus colecciones más completas, **Architect S+**, con más de 25 accesorios diferentes pensados para ofrecer la máxima funcionalidad, incorporando en su gama 4 nuevos acabados para poder encajar en cualquier estilo de baño. La nueva propuesta destaca por incorporar en muchas de las piezas una gran variedad de acabados, convirtiendo a la colección **Architect S+** en una colección segura, superior, sostenible, resolutive y ahora, más versátil que nunca. Porque **Cosmic es Innovation's Mind**.



**Architect S+** has successfully passed the high demanding tests of long last durability and resistance to extreme uses (static charge or impact testing) to assure long last durability of the product. All products come with 10 years warranty.

Toda la gama **Architect S+** ha superado con éxito exigentes tests de durabilidad y resistencia a usos extremos (cargas estáticas o test de impacto), para asegurar una larga vida al producto. Todos los artículos tienen 10 años de garantía

### Fixing disc (wall plate)

The fiberglass mix makes the fixing disc highly resistant. It adapts to the shape of the screw to remain completely fixed.

### Disco de fijación (wall plate)

La mezcla con fibra de vidrio hace que el disco de fijación sea muy resistente. Se adapta a la forma del tornillo, quedando completamente fijado.

### Triple fixing

### Triple fijación

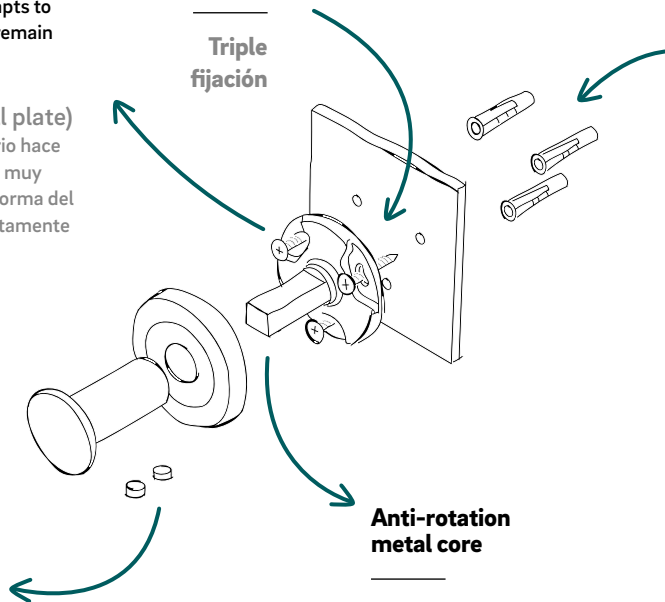

### Two Allen carriage bolts

that are hidden and prevent extraction of the accessory.

### Dos tornillos ciegos allen

que quedan ocultos y privan la extracción del accesorio.

### Fischer DuoPower wall plugs.

Strong and universal: anchoring with superior performance. This is the **first smart anchoring system** that decides whether to expand, fold or knit together depending on the wall's material.

### Tacos Fischer DuoPower:

Fuerte y Universal: el anclaje con un rendimiento superior. Es el **primer anclaje inteligente** que decide si se expande, se pliega o se anuda según el material de la pared.

### Fischer DuoPower



Video de instalación

Video de instalación



# Accessories | Accesorios



HOOK  
COLGADOR

- S **WJC205A0021001**  
CHROME / CROMO
- WJC205A0021036**  
BLACK MATT / NEGRO MATE
- WJC205A0021065**  
MATT WHITE / BLANCO MATE
- WJC205A0021003**  
BRUSHED STEEL / INOX CEPILLADO
- WJC205A0021054**  
BRUSHED COPPER PVD / COBRE CEPILLADO PVD
- WJC205A0021040**  
BRUSHED GOLD PVD / ORO CEPILLADO PVD
- WJC205A0021055**  
BRUSHED BLACK PVD / NEGRO CEPILLADO PVD

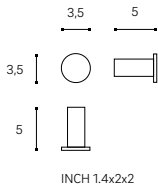

HOOK  
COLGADOR

- S **WJC235A0021001**  
CHROME / CROMO
- S **WJC235A0021036**  
BLACK MATT / NEGRO MATE
- WJC235A0021065**  
MATT WHITE / BLANCO MATE
- S **WJC235A0021003**  
BRUSHED STEEL / INOX CEPILLADO
- WJC235A0021054**  
BRUSHED COPPER PVD / COBRE CEPILLADO PVD
- WJC235A0021040**  
BRUSHED GOLD PVD / ORO CEPILLADO PVD
- WJC235A0021055**  
BRUSHED BLACK PVD / NEGRO CEPILLADO PVD

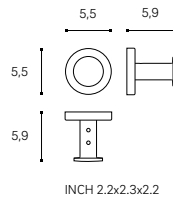

FREE STANDING BRUSH-HOLDER  
PORTACEPILLOS ENCIMERA

- WJC205A0051001**  
CHROME / CROMO
- WJC205A0051036\***  
BLACK MATT / NEGRO MATE
- WJC205A0051065\***  
MATT WHITE / BLANCO MATE
- WJC205A0051003\***  
BRUSHED STEEL / INOX CEPILLADO
- WJC205A0051054\***  
BRUSHED COPPER PVD / COBRE CEPILLADO PVD
- WJC205A0051040\* €**  
BRUSHED GOLD PVD / ORO CEPILLADO PVD
- WJC205A0051055\***  
BRUSHED BLACK PVD / NEGRO CEPILLADO PVD

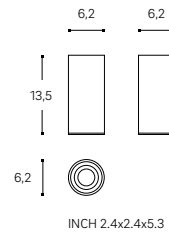

BRUSH-HOLDER  
PORTACEPILLOS

- WJC205A0053001**  
CHROME / CROMO
- WJC205A0053036\***  
BLACK MATT / NEGRO MATE
- WJC205A0053065\***  
MATT WHITE / BLANCO MATE
- WJC205A0053003\***  
BRUSHED STEEL / INOX CEPILLADO
- WJC205A0053054\***  
BRUSHED COPPER PVD / COBRE CEPILLADO PVD
- WJC205A0053040\***  
BRUSHED GOLD PVD / ORO CEPILLADO PVD
- WJC205A0053055\* €**  
BRUSHED BLACK PVD / NEGRO CEPILLADO PVD

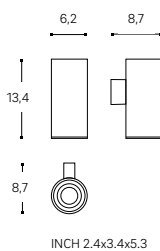

FREE STANDING SOAP DISPENSER 240 ML  
DOSIFICADOR ENCIMERA 240 ML

- S **WJC205A0004001**  
CHROME / CROMO
- WJC205A0004036\***  
BLACK MATT / NEGRO MATE
- WJC205A0004065\***  
MATT WHITE / BLANCO MATE
- WJC205A0004003\***  
BRUSHED STEEL / INOX CEPILLADO
- WJC205A0004054\***  
BRUSHED COPPER PVD / COBRE CEPILLADO PVD
- WJC205A0004040\***  
BRUSHED GOLD PVD / ORO CEPILLADO PVD
- WJC205A0004055\***  
BRUSHED BLACK PVD / NEGRO CEPILLADO PVD

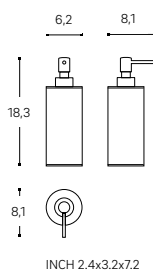

SOAP DISPENSER 240 ML  
DOSIFICADOR 240 ML

- S **WJC205A0003001**  
CHROME / CROMO
- WJC419A0003036\***  
BLACK MATT / NEGRO MATE
- WJC205A0003065\***  
MATT WHITE / BLANCO MATE
- WJC205A0003003\***  
BRUSHED STEEL / INOX CEPILLADO
- WJC205A0003054\***  
BRUSHED COPPER PVD / COBRE CEPILLADO PVD
- WJC205A0003040\***  
BRUSHED GOLD PVD / ORO CEPILLADO PVD
- WJC205A0003055\***  
BRUSHED BLACK PVD / NEGRO CEPILLADO PVD

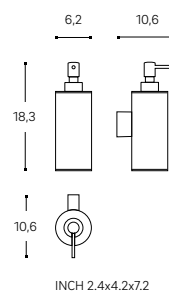

\* CHECK AVAILABILITY  
\* CONSULTAR DISPONIBILIDAD



TOWEL RACK 30 CM  
TOALLERO 30 CM

- S** **WJC235A0063001**  
CHROME / CROMO
- S** **WJC235A0063036**  
BLACK MATT / NEGRO MATE
- WJC235A0063065**  
MATT WHITE / BLANCO MATE
- S** **WJC235A0063003**  
BRUSHED STEEL / INOX CEPILLADO
- WJC235A0063054**  
BRUSHED COPPER PVD / COBRE CEPILLADO PVD
- WJC235A0063040**  
BRUSHED GOLD PVD / ORO CEPILLADO PVD
- WJC235A0063055**  
BRUSHED BLACK PVD / NEGRO CEPILLADO PVD

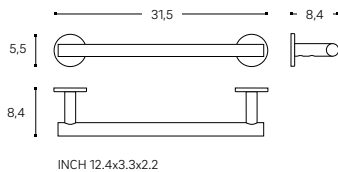

INCH 12.4x3.3x2.2



TOWEL RACK 45 CM  
TOALLERO 45 CM

- S** **WJC235A0064001**  
CHROME / CROMO
- S** **WJC235A0064036**  
BLACK MATT / NEGRO MATE
- WJC235A0064065**  
MATT WHITE / BLANCO MATE
- S** **WJC235A0064003**  
BRUSHED STEEL / INOX CEPILLADO
- WJC235A0064054**  
BRUSHED COPPER PVD / COBRE CEPILLADO PVD
- WJC235A0064040**  
BRUSHED GOLD PVD / ORO CEPILLADO PVD
- WJC235A0064055**  
BRUSHED BLACK PVD / NEGRO CEPILLADO PVD

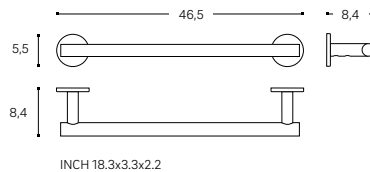

INCH 18.3x3.3x2.2



TOWEL RACK 60 CM  
TOALLERO 60 CM

- S** **WJC235A0065001**  
CHROME / CROMO
- WJC235A0065036**  
BLACK MATT / NEGRO MATE
- WJC235A0065003**  
MATT WHITE / BLANCO MATE

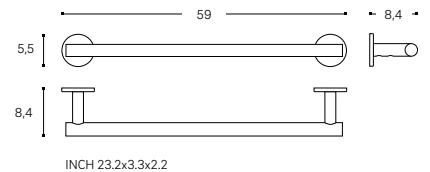

INCH 23.2x3.3x2.2



TOWEL RACK  
TOALLERO

- S** **WJC235A0069001**  
CHROME / CROMO
- S** **WJC235A0069036**  
BLACK MATT / NEGRO MATE
- WJC235A0069065**  
MATT WHITE / BLANCO MATE
- S** **WJC235A0069003**  
BRUSHED STEEL / INOX CEPILLADO
- WJC235A0069054**  
BRUSHED COPPER PVD / COBRE CEPILLADO PVD
- WJC235A0069040**  
BRUSHED GOLD PVD / ORO CEPILLADO PVD
- WJC235A0069055**  
BRUSHED BLACK PVD / NEGRO CEPILLADO PVD

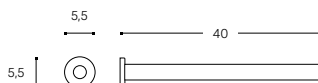

INCH 2.2x15.7x2.2



TOWEL RING  
TOALLERO ARO

- S** **WJC235A0071001**  
CHROME / CROMO
- S** **WJC235A0071036**  
BLACK MATT / NEGRO MATE
- WJC235A0071065**  
MATT WHITE / BLANCO MATE
- S** **WJC235A0071003**  
BRUSHED STEEL / INOX CEPILLADO
- WJC235A0071054**  
BRUSHED COPPER PVD / COBRE CEPILLADO PVD
- WJC235A0071040**  
BRUSHED GOLD PVD / ORO CEPILLADO PVD
- WJC235A0071055**  
BRUSHED BLACK PVD / NEGRO CEPILLADO PVD

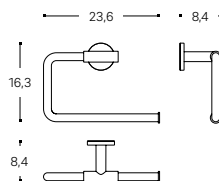

INCH 9.3x3.3x6.4



WALL MAGNIFYING MIRROR (X5)  
ESPEJO DE AUMENTO PARED (X5)

- S** **WJC235A0085001**  
CHROME / CROMO
- S** **WJC235A0085036**  
BLACK MATT / NEGRO MATE
- WJC235A0085065**  
MATT WHITE / BLANCO MATE
- S** **WJC235A0085003**  
BRUSHED STEEL / INOX CEPILLADO
- WJC235A0085054**  
BRUSHED COPPER PVD / COBRE CEPILLADO PVD
- WJC235A0085040**  
BRUSHED GOLD PVD / ORO CEPILLADO PVD
- WJC235A0085055**  
BRUSHED BLACK PVD / NEGRO CEPILLADO PVD

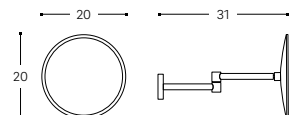

INCH 7.9x12.2x7.9





SHOWER SOAP DISH  
JABONERA DE DUCHA

- WJC235A0049001  
CHROME / CROMO
- WJC235A0049036  
BLACK MATT / NEGRO MATE
- WJC235A0049065  
MATT WHITE / BLANCO MATE
- WJC235A0049003  
BRUSHED STEEL / INOX CEPILLADO
- WJC235A0049054  
BRUSHED COPPER PVD / COBRE CEPILLADO PVD
- WJC235A0049040  
BRUSHED GOLD PVD / ORO CEPILLADO PVD
- WJC235A0049055  
BRUSHED BLACK PVD / NEGRO CEPILLADO PVD

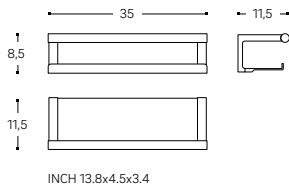

SHOWER SOAP DISH WITH GLASS WIPER  
JABONERA DUCHA CON LIMPIACRISTALES

- WJC235A0048001  
CHROME / CROMO
- WJC235A0048036  
BLACK MATT / NEGRO MATE
- WJC235A0048065  
MATT WHITE / BLANCO MATE
- WJC235A0048003  
BRUSHED STEEL / INOX CEPILLADO
- WJC235A0048054  
BRUSHED COPPER PVD / COBRE CEPILLADO PVD
- WJC235A0048040  
BRUSHED GOLD PVD / ORO CEPILLADO PVD
- WJC235A0048055  
BRUSHED BLACK PVD / NEGRO CEPILLADO PVD

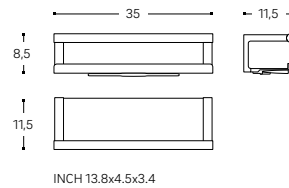

PAPER HOLDER WITH COVER  
PORTAPAPEL CON TAPA

- WJC235A0059001  
CHROME / CROMO
- WJC235A0059036  
BLACK MATT / NEGRO MATE
- WJC235A0059065  
MATT WHITE / BLANCO MATE
- WJC235A0059003  
BRUSHED STEEL / INOX CEPILLADO
- WJC235A0059054  
BRUSHED COPPER PVD / COBRE CEPILLADO PVD
- WJC235A0059040  
BRUSHED GOLD PVD / ORO CEPILLADO PVD
- WJC235A0059055  
BRUSHED BLACK PVD / NEGRO CEPILLADO PVD

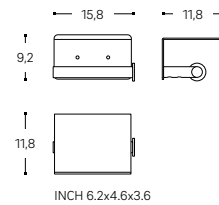

PAPER HOLDER WITHOUT COVER  
PORTAPAPEL SIN TAPA

- WJC235A0058001  
CHROME / CROMO
- WJC235A0058036  
BLACK MATT / NEGRO MATE
- WJC235A0058065  
MATT WHITE / BLANCO MATE
- WJC235A0058003  
BRUSHED STEEL / INOX CEPILLADO
- WJC235A0058054  
BRUSHED COPPER PVD / COBRE CEPILLADO PVD
- WJC235A0058040  
BRUSHED GOLD PVD / ORO CEPILLADO PVD
- WJC235A0058055  
BRUSHED BLACK PVD / NEGRO CEPILLADO PVD

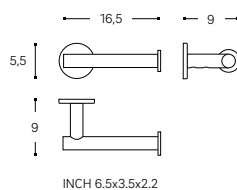

FREE STANDING TOILET BRUSH  
ESCOBILLERO SUELO

- WJC235A0001001  
CHROME / CROMO
- WJC235A0001036  
BLACK MATT / NEGRO MATE
- WJC235A0001065  
MATT WHITE / BLANCO MATE
- WJC235A0001003  
BRUSHED STEEL / INOX CEPILLADO
- WJC235A0001054  
BRUSHED COPPER PVD / COBRE CEPILLADO PVD
- WJC235A0001040  
BRUSHED GOLD PVD / ORO CEPILLADO PVD
- WJC235A0001055  
BRUSHED BLACK PVD / NEGRO CEPILLADO PVD

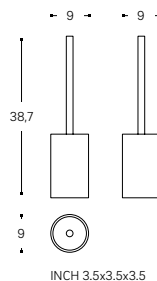

TOILET BRUSH  
ESCOBILLERO

- WJC235A0000001  
CHROME / CROMO
- WJC235A0000036  
BLACK MATT / NEGRO MATE
- WJC235A0000065  
MATT WHITE / BLANCO MATE
- WJC235A0000003  
BRUSHED STEEL / INOX CEPILLADO
- WJC235A0000054  
BRUSHED COPPER PVD / COBRE CEPILLADO PVD
- WJC235A0000040  
BRUSHED GOLD PVD / ORO CEPILLADO PVD
- WJC235A0000055  
BRUSHED BLACK PVD / NEGRO CEPILLADO PVD

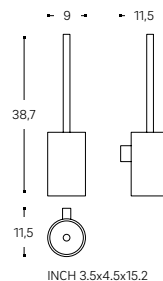



○  
HOOK (X2)  
PERCHA (X2)

- WJC235A0023001**  
CHROME / CROMO
- WJC235A0023003**  
BRUSHED STEEL / INOX CEPILLADO
- WJC235A0023036**  
SOFT BLACK

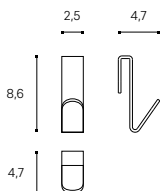

INCH 1x1.9x3.4



⊙△  
BRUSH-HOLDER  
PORTACEPILLOS

- WJC235A0053001**  
CHROME / CROMO
- WJC235A0053003**  
BRUSHED STEEL / INOX CEPILLADO
- WJC235A0053036**  
SOFT BLACK

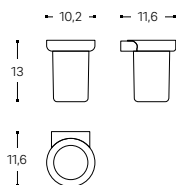

INCH 4x4.6x5.1



⊙△  
SOAP DISPENSER 400 ML  
DOSIFICADOR 400 ML

- WJC235A0003001**  
CHROME / CROMO
- WJC235A0003003**  
BRUSHED STEEL / INOX CEPILLADO
- WJC235A0003036**  
SOFT BLACK

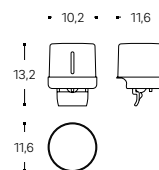

INCH 4x4.6x5.2



○  
TISSUE BOX  
CAJA KLEENEX

- WJC235A0028002**  
CHROME / CROMO
- WJC235A0028003**  
BRUSHED STEEL / INOX CEPILLADO
- WJC235A0028036**  
SOFT BLACK

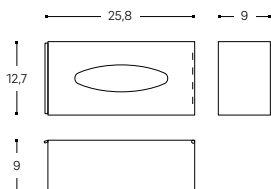

INCH 10.1x3.5x5



⊙⊙  
SHELF  
ESTANTE

- WJC235A0044001**  
CHROME / CROMO
- WJC235A0044003**  
BRUSHED STEEL / INOX CEPILLADO
- WJC235A0044036**  
SOFT BLACK

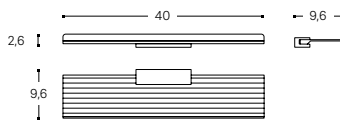

INCH 15.6x3.8x1



△  
TRAY  
BANDEJA

- WJC235A0033034**  
SMOKED / FUMÉ

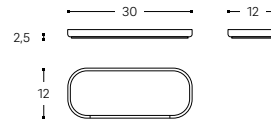

INCH 11.8x4.7x1





DOUBLE HANGING SHOWER SOAP DISH  
DOBLE JABONERA DE DUCHA COLGANTE

**WJC235A0047001**  
CHROME / CROMO

**WJC235A0047036**  
SOFT BLACK

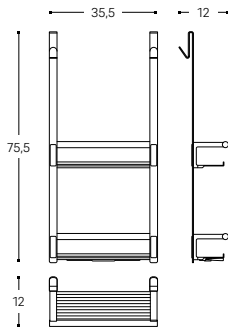

INCH 14x4.7x29.7



DOUBLE TOWEL RACK  
TOALLERO DOBLE

**WJC235A0061001**  
45 CM / INCH 17.7 CHROME / CROMO

**WJC235A0060001**  
60 CM / INCH 23.6 CHROME / CROMO

**WJC235A0061003**  
45 CM / INCH 17.7 BRUSHED STEEL / INOX CEPILLADO

**WJC235A0060003**  
60 CM / INCH 23.6 BRUSHED STEEL / INOX CEPILLADO

**WJC235A0061036**  
45 CM / INCH 17.7 SOFT BLACK

**WJC235A0060036**  
60 CM / INCH 23.6 SOFT BLACK

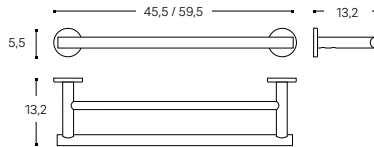

INCH 17.9/23.2x5.2x2.2



SWIVEL DOUBLE TOWEL RACK  
TOALLERO GIRATORIO DOBLE

**WJC235A0075001**  
CHROME / CROMO

**WJC235A0075003**  
BRUSHED STEEL / INOX CEPILLADO

**WJC235A0075036**  
SOFT BLACK

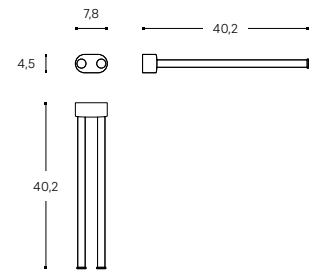

INCH 3x15.8x1.8

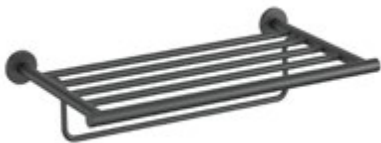

TOWEL RACK SHELF  
TOALLERO ESTANTE

**WJC235A0068001**  
CHROME / CROMO

**WJC235A0068003**  
BRUSHED STEEL / INOX CEPILLADO

**WJC235A0068036**  
SOFT BLACK

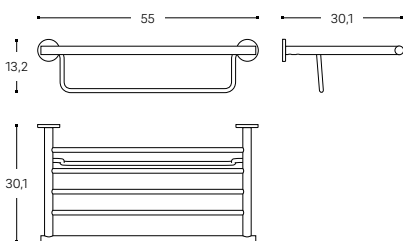

INCH 21.6x11.8x5.2



GRAB BAR  
ASA BAÑERA

**WJC235A0024001**  
30 CM / INCH 11.8 CHROME / CROMO

**WJC235A0025001**  
45 CM / INCH 17.7 CHROME / CROMO

**WJC235A0024003**  
30 CM / INCH 11.8 BRUSHED STEEL / INOX CEPILLADO

**WJC235A0025003**  
45 CM / INCH 17.7 BRUSHED STEEL / INOX CEPILLADO

**WJC235A0024036**  
30 CM / INCH 11.8 SOFT BLACK

**WJC235A0025036**  
45 CM / INCH 17.7 SOFT BLACK

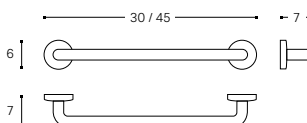

INCH 11.8/17.7x2.7x2.3  
Ø 22 MM / INCH 0.9



GRAB BAR 45 CM  
ASA BAÑERA 45 CM

**WJC205A0011001**  
CHROME / CROMO

**WJC419A0011036**  
SOFT BLACK

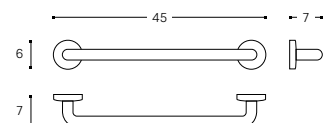

INCH 17.7x2.7x2.3  
Ø 22 MM / INCH 0.9



PAPER HOLDER WITHOUT COVER  
PORTAPAPEL SIN TAPA

- WJC235A0062001**  
CHROME / CROMO
- S** **WJC235A0062003**  
BRUSHED STEEL / INOX CEPILLADO
- S** **WJC235A0062036**  
SOFT BLACK

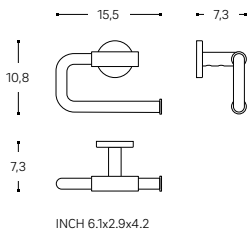

DOUBLE PAPER HOLDER WITHOUT COVER  
PORTAPAPEL DOBLE SIN TAPA

- WJC235A0057001**  
CHROME / CROMO
- WJC235A0057003**  
BRUSHED STEEL / INOX CEPILLADO
- WJC235A0057036**  
SOFT BLACK

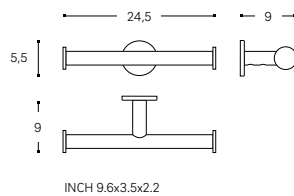

VERTICAL PAPER HOLDER  
PORTAPAPEL VERTICAL

- S** **WJC235A0096001**  
CHROME / CROMO
- S** **WJC235A0096003**  
BRUSHED STEEL / INOX CEPILLADO
- S** **WJC235A0096036**  
SOFT BLACK

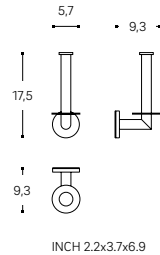

5L WASTE BIN  
PAPELERA 5L

- WJC235A0002001**  
CHROME / CROMO
- WJC235A0002003**  
BRUSHED STEEL / INOX CEPILLADO
- WJC277A0002036**  
SOFT BLACK

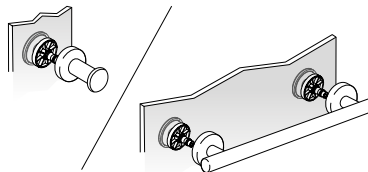
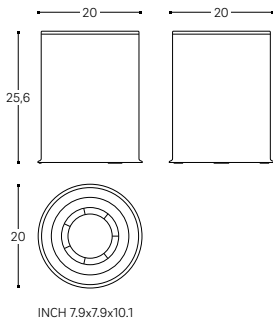

GLASS SHOWER ENCLOSURE HOLDER FOR HOOK  
SOPORTE MAMPARA PARA COLGADOR

- GLASS 6/8MM / VIDRIO 6/8MM
- WJC235A0040001**  
CHROME / CROMO

- WJC235A0040003**  
BRUSHED STEEL / INOX CEPILLADO
- WJC235A0040036**  
SOFT BLACK

GLASS SHOWER ENCLOSURE HOLDER  
FOR TOWEL RACK (2U. REQUIRED)  
SOPORTE MAMPARA PARA TOALLERO (REQUIERE 2 U.)

- GLASS 6/8MM / VIDRIO 6/8MM
- WJC235A0040001**  
CHROME / CROMO

- WJC235A0040003**  
BRUSHED STEEL / INOX CEPILLADO
- WJC235A0040003**  
BRUSHED STEEL / INOX CEPILLADO

- WJC235A0040036**  
SOFT BLACK
- WJC235A0040036**  
SOFT BLACK

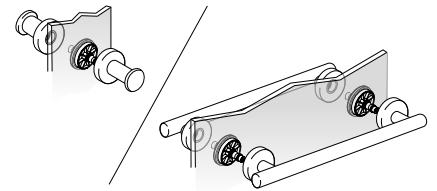
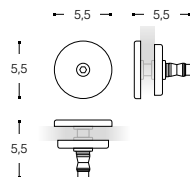

GLASS SHOWER ENCLOSURE HOLDER FOR HOOK / HOOK  
SOPORTE MAMPARA PARA COLGADOR / COLGADOR

- GLASS 6/8MM / VIDRIO 6/8MM

- WJC235A0042000**

GLASS SHOWER ENCLOSURE HOLDER FOR  
TOWEL RACK / TOWEL RACK (2U. REQUIRED)  
SOPORTE MAMPARA PARA TOALLERO / TOALLERO (REQUIERE 2 U.)

- GLASS 6/8MM / VIDRIO 6/8MM

- WJC235A0042000**

- WJC235A0042000**

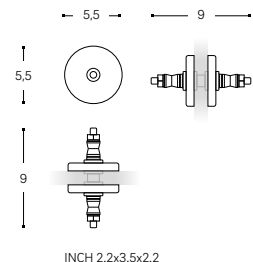



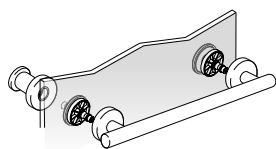

GLASS SHOWER ENCLOSURE HOLDER FOR TOWEL RACK / HOOK  
SOPORTE MAMPARA PARA TOALLERO / COLGADOR

GLASS 6/8MM / VIDRIO 6/8MM

**WJC235A0042000**

+

**WJC235A0040001**

CHROME / CROMO

**WJC235A0042000**

+

**WJC235A0040003**

BRUSHED STEEL / INOX CEPILLADO

**WJC235A0042000**

+

**WJC235A0040036**

SOFT BLACK

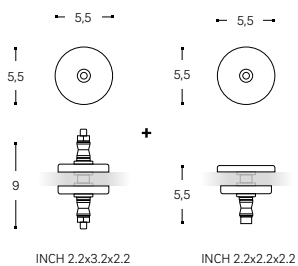

SHOWER SOAP DISH COMBINATIONS  
COMBINACIONES JABONERA DUCHA



**WJC235A0049001**  
CHROME / CROMO



**WJC235A0049036**  
BLACK MATT / NEGRO MATE



**WJC235A0049065**  
MATT WHITE / BLANCO MATE



**WJC235A0049003**  
BRUSHED STEEL / INOX CEPILLADO



**WJC235A0049054**  
BRUSHED COPPER PVD / COBRE CEPILLADO PVD



**WJC235A0049040**  
BRUSHED GOLD PVD / ORO CEPILLADO PVD



**WJC235A0049055**  
BRUSHED BLACK PVD / NEGRO CEPILLADO PVD

# Next

Design by **Cosmic Studio**



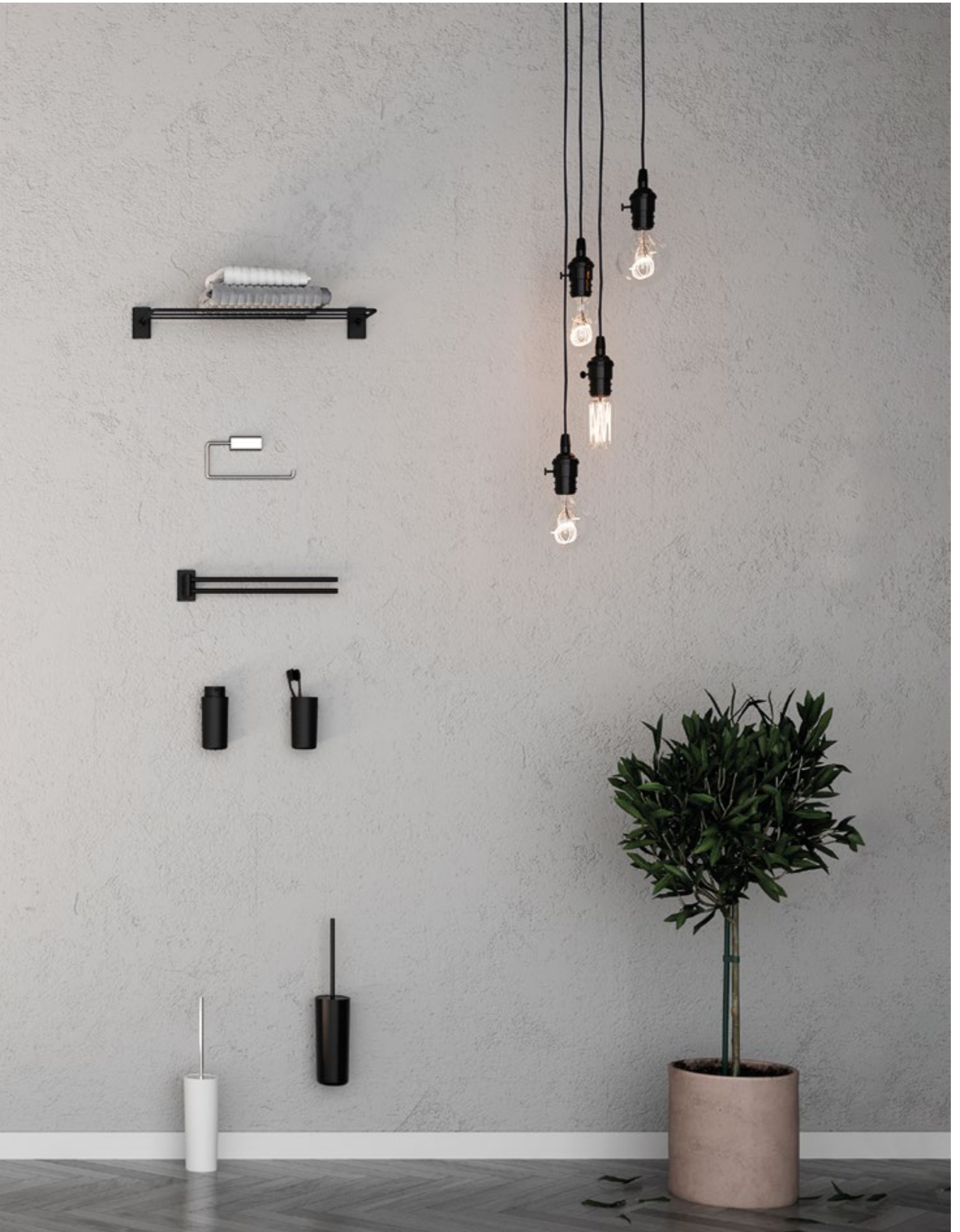

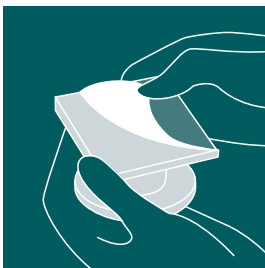

# QUICK FIX



Easy installation  
without drilling

Fácil instalación  
sin taladro



Bonded with  
high adhesion  
adhesive

Fijación con  
adhesivo de alta  
adherencia



Quick, easy, silent  
installation

Montaje sin ruido,  
fácil y rápido



Static load  
of 5 kg

Carga estática  
de 5 KG



Do not use on  
painted surfaces  
and gypsum walls

No usar en  
superficies pintadas  
ni en paredes rugosas



**Next** has successfully passed the high demanding tests of long last durability and resistance to extreme uses (static charge or impact testing) to assure long last durability of the product. All products come with 10 years warranty.

Toda la gama **Next** ha superado con éxito exigentes tests de durabilidad y resistencia a usos extremos (cargas estáticas o test de impacto), para asegurar una larga vida al producto. Todos los artículos tienen 10 años de garantía

**Next** emerged with the aim of taking design to any type of bathroom. Created with people in mind, it offers a dual fixing system with an efficient double-sided adhesive. This is in addition to two different finishes (**Chrome** and **Soft Black**), allowing it to fit in with all kinds of styles. **Next** is a functional collection with a designer touch that will suit all budgets.

**Next** nace con el objetivo de poder llevar diseño a cualquier tipo de baño. Diseñada pensando en las personas, ofrece un sistema de fijación **Dual** con un eficiente adhesivo de doble cara. Y dos acabados diferentes,  **cromado y negro Soft**, para encajar en todo tipo de estilos. Una colección funcional con un toque de diseño para todo tipo de presupuestos.

**FINISHES / ACABADOS**



**001**  
Chrome  
Cromo



**036**  
Black matt  
Negro mate

## Soft Black

**Cosmic** has developed a new **Soft Black** finish for **Next** with an extra matte texture

**Cosmic** ha desarrollado para **Next** un nuevo acabado **Soft Black**, que destaca por ser extra mate

From automotive engineering to your bathroom

Desde la ingeniería automotriz hasta tu baño

Highly scratch resistant

Muy resistente a los rasguños

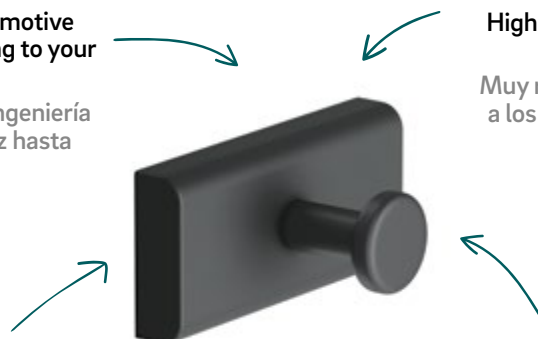

Strong and long-lasting  
Resistente y duradero

Uniform and compact black coating  
Recubrimiento negro compacto y uniforme





⊙△  
**HOOK**  
 COLGADOR

**WJC215A0021001**  
 CHROME / CROMO  
**WJC215A0021036**  
 BLACK MATT / NEGRO MATE

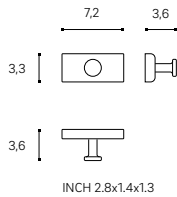

⊙△  
**DOUBLE HOOK**  
 COLGADOR DOBLE

**WJC215A0022001**  
 CHROME / CROMO  
**WJC215A0022036**  
 BLACK MATT / NEGRO MATE

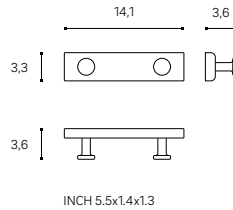

⊙  
**FREE STANDING BRUSH-HOLDER**  
 PORTACEPILLOS ENCIMERA

**WJC215A0053001**  
 CHROME / CROMO  
**WJC215A0053036**  
 BLACK MATT / NEGRO MATE

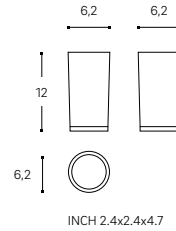

⊙  
**BRUSH-HOLDER**  
 PORTACEPILLOS

**WJC215A0052001**  
 CHROME / CROMO  
**WJC215A0052036**  
 BLACK MATT / NEGRO MATE

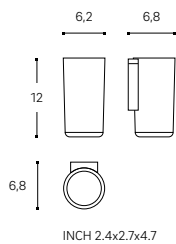

⊙△○  
**FREE STANDING SOAP DISPENSER 200 ML**  
 DOSIFICADOR ENCIMERA 200 ML

**WJC215A0004001**  
 CHROME / CROMO  
**WJC215A0004036**  
 BLACK MATT / NEGRO MATE

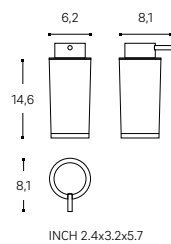

⊙△○  
**SOAP DISPENSER 200 ML**  
 DOSIFICADOR 200 ML

**WJC215A0005001**  
 CHROME / CROMO  
**WJC215A0005036**  
 BLACK MATT / NEGRO MATE

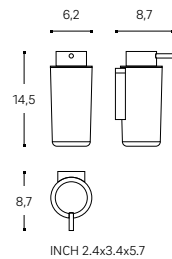



TOWEL RACK 30 CM  
TOALLERO 30 CM

**WJC215A0063001**  
CHROME / CROMO  
**WJC215A0063036**  
BLACK MATT / NEGRO MATE

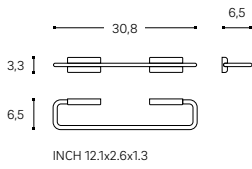

TOWEL RACK 40 CM  
TOALLERO 40 CM

**WJC215A0064001**  
CHROME / CROMO  
**WJC215A0064036**  
BLACK MATT / NEGRO MATE

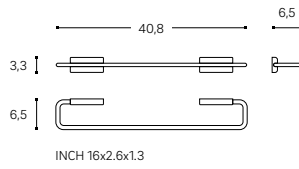

TOWEL RACK 60 CM  
TOALLERO 60 CM

**WJC215A0065001**  
CHROME / CROMO  
**WJC215A0065036**  
BLACK MATT / NEGRO MATE

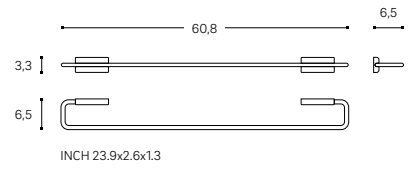

TOWEL RING  
TOALLERO ARO

**WJC215A0071001**  
CHROME / CROMO  
**WJC215A0071036**  
BLACK MATT / NEGRO MATE

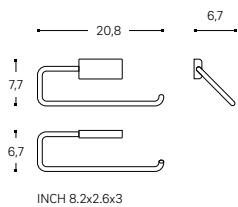

SWIVEL DOUBLE TOWEL RACK  
TOALLERO GIRATORIO DOBLE

**WJC215A0075001**  
CHROME / CROMO  
**WJC215A0075036**  
BLACK MATT / NEGRO MATE

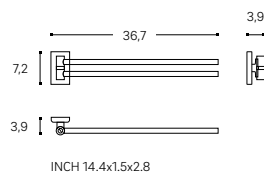

SHELF TOWEL RACK  
TOALLERO ESTANTE

**WJC215A0068001**  
CHROME / CROMO  
**WJC215A0068036**  
BLACK MATT / NEGRO MATE

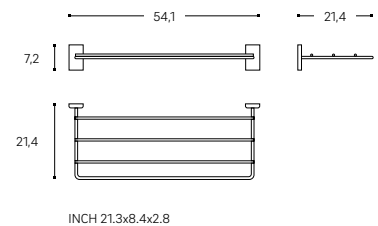



PAPER HOLDER WITH COVER  
PORTAPAPEL CON TAPA

**WJC215A0059001**  
CHROME / CROMO

**WJC215A0059036**  
BLACK MATT / NEGRO MATE

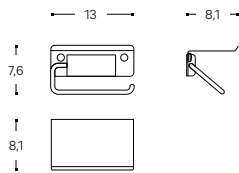

INCH 5.1x3.2x3



PAPER HOLDER WITHOUT COVER  
PORTAPAPEL SIN TAPA

**WJC215A0058001**  
CHROME / CROMO

**WJC215A0058036**  
BLACK MATT / NEGRO MATE

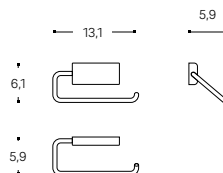

INCH 5.2x2.2x2.4



SPARE PAPER HOLDER  
PORTAPAPEL RESERVA

**WJC215A0096001**  
CHROME / CROMO

**WJC215A0096036**  
BLACK MATT / NEGRO MATE

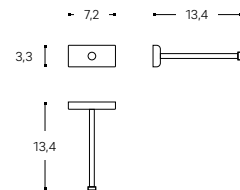

INCH 2.8x5.3x1.3



FREE STANDING TOILET BRUSH  
ESCOBILLERO SUELO

**WJC215A0001001**  
CHROME / CROMO

**WJC215A0001036**  
BLACK MATT / NEGRO MATE

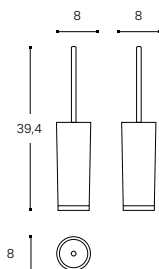

INCH 3.1x3.1x15.5



TOILET BRUSH  
ESCOBILLERO

**WJC215A0000001**  
CHROME / CROMO

**WJC215A0000036**  
BLACK MATT / NEGRO MATE

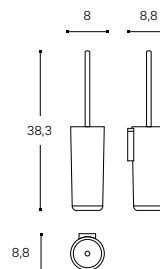

INCH 3.1x3.5x15.1





# Start

Design by **Cosmic Studio**









**Start** has successfully passed the high demanding tests of long last durability and resistance to extreme uses (static charge or impact testing) to assure long last durability of the product. All products come with 10 years warranty.

Toda la gama **Start** ha superado con éxito exigentes tests de durabilidad y resistencia a usos extremos (cargas estáticas o test de impacto), para asegurar una larga vida al producto. Todos los artículos tienen 10 años de garantía

**Start is designed for people who appreciate simplicity in design. Each piece in this collection has a smooth, stylish shape that masterfully combines with a variety of modern settings. This is a full range of bathroom accessories comprising shower caddies with a removable tray, available in two finishes, chrome and matte black.**

**Start está diseñada para personas que aprecian la simplicidad en el diseño. Cada pieza de esta colección tiene una forma suave y elegante que combina a la perfección con una variedad de ambientes contemporáneos. Colección completa de accesorios para el baño que integra jaboneras de ducha con bandeja extraíble, disponible en dos acabados cromo y negro mate.**

**FINISHES / ACABADOS**



**001**  
Chrome  
Cromo



**036**  
Black matt  
Negro mate

## Soft Black

**Cosmic has developed a new Soft Black finish for Start with an extra matte texture**

**Cosmic ha desarrollado para Start un nuevo acabado Soft Black, que destaca por ser extra mate**

From automotive engineering to your bathroom

Desde la ingeniería automotriz hasta tu baño

Strong and long-lasting  
Resistente y duradero

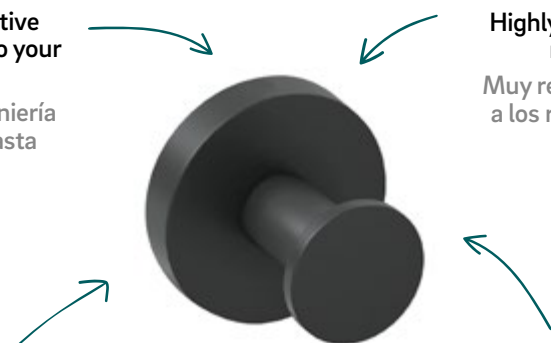

Highly scratch resistant  
Muy resistente a los rasguños

Uniform and compact black coating  
Recubrimiento negro compacto y uniforme



⊙  
HOOK  
COLGADOR

**WJC419A0021001**  
CHROME / CROMO  
**WJC419A0021036**  
BLACK MATT / NEGRO MATE

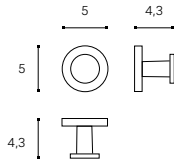

INCH 2x1.7x2



⊙  
DOUBLE HOOK  
COLGADOR DOBLE

**WJC419A0022001**  
CHROME / CROMO  
**WJC419A0022036**  
BLACK MATT / NEGRO MATE

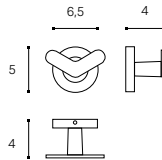

INCH 2.6x1.6x2



⊙◇  
SOAP DISH  
JABONERA

**WJC419A0032001**  
CHROME / CROMO  
**WJC419A0032036**  
BLACK MATT / NEGRO MATE

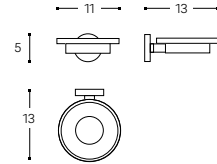

INCH 4.3x5.1x2



⊙  
SOAP DISH  
JABONERA

**WJC419A0030001**  
CHROME / CROMO  
**WJC419A0030036**  
BLACK MATT / NEGRO MATE

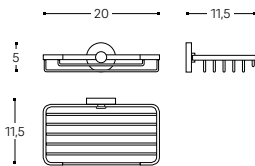

INCH 7.9x4.5x2



⊙  
REMOVABLE CORNER SHOWER BASKET  
JABONERA DE DUCHA RINCÓN EXTRAÍBLE

**WJB269A0050001**  
CHROME / CROMO  
**WJC419A0050036**  
BLACK MATT / NEGRO MATE

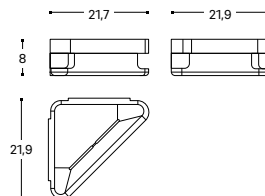

INCH 8.5x8.6x3.1

CAN BE EASILY TAKEN APART FOR CLEANING. EXTRACTABLE SOAP DISH.  
FÁCIL EXTRACCIÓN PARA SU LIMPIEZA. JABONERA EXTRAÍBLE.



⊙  
REMOVABLE SHOWER BASKET  
JABONERA DE DUCHA EXTRAÍBLE

**WJB269A0049001**  
CHROME / CROMO  
**WJC419A0049036**  
BLACK MATT / NEGRO MATE

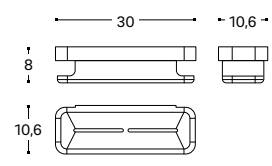

INCH 11.8x4.17x3.1

CAN BE EASILY TAKEN APART FOR CLEANING. EXTRACTABLE SOAP DISH.  
FÁCIL EXTRACCIÓN PARA SU LIMPIEZA. JABONERA EXTRAÍBLE.





FREE STANDING BRUSH-HOLDER  
PORTACEPILLOS ENCIMERA

**WJC226A0051002**  
GLOSSY INOX / INOX BRILLO

**WJC226A0051036**  
BLACK MATT / NEGRO MATE

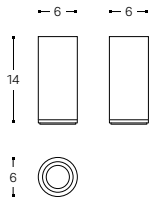

INCH 2.4x3.5x5.5



BRUSH-HOLDER  
PORTACEPILLOS

**WJC226A0003002**  
GLOSSY INOX / INOX BRILLO

**WJC226A0003036**  
BLACK MATT / NEGRO MATE

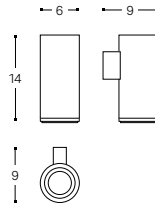

INCH 2.4x3.5x5.5



BRUSH-HOLDER  
PORTACEPILLOS

**WJC419A0052001**  
CHROME / CROMO

**WJC419A0052036**  
BLACK MATT / NEGRO MATE

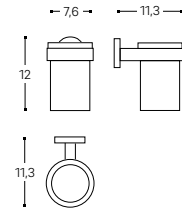

INCH 3x4.5x2.2



FREE STANDING SOAP DISPENSER 200 ML  
DOSIFICADOR ENCIMERA 200 ML

**WJC226A0053002**  
GLOSSY INOX / INOX BRILLO

**WJC226A0053036**  
BLACK MATT / NEGRO MATE

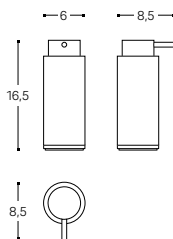

INCH 2.4x3.3x6.5



SOAP DISPENSER 200 ML  
DOSIFICADOR 200 ML

**WJC226A0004002**  
GLOSSY INOX / INOX BRILLO

**WJC226A0004036**  
BLACK MATT / NEGRO MATE

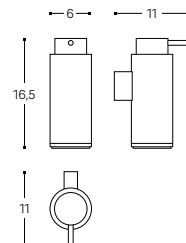

INCH 2.4x4.3x6.5



SOAP DISPENSER 200 ML  
DOSIFICADOR 200 ML

**WJC419A0005001**  
CHROME / CROMO

**WJC419A0005036**  
BLACK MATT / NEGRO MATE

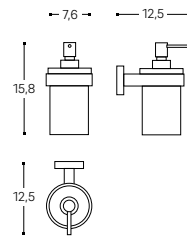

INCH 3x4.9x6.2





◆ ◎  
SHELF 40 CM  
ESTANTE 40 CM

**WJC419A0044001**  
CHROME / CROMO  
**WJC419A0044036**  
BLACK MATT / NEGRO MATE

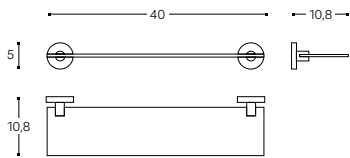

INCH 15.7x4.3x2



◎  
TOWEL RACK 40 CM  
TOALLERO 40 CM

**WJC419A0064001**  
40 CM CROMO / CHROM  
**WJC419A0064036**  
40 CM BLACK MATT / NEGRO MATE  
**WJC419A0065001**  
60 CM CROMO / CHROM  
**WJC419A0065036**  
60 CM BLACK MATT / NEGRO MATE

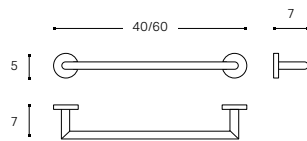

INCH 15.7/23.6x2.8x2



○ ◎  
TOWEL RACK SHELF  
TOALLERO ESTANTE

**WJC419A0068001**  
CHROME / CROMO  
**WJC419A0068036**  
BLACK MATT / NEGRO MATE

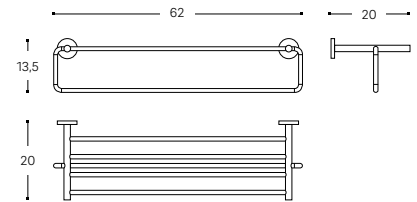

INCH 23.6x7.9x2



○ ◎  
TOWEL RING  
TOALLERO ARO

**WJC419A0072001**  
CHROME / CROMO  
**WJC419A0072036**  
BLACK MATT / NEGRO MATE

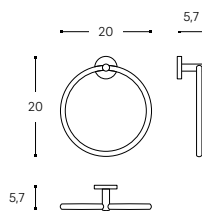

INCH 7.9x2.2x7.9



○ ◎  
PAPER HOLDER WITH COVER  
PORTAPAPEL CON TAPA

**WJC419A0059001**  
CHROME / CROMO  
**WJC419A0059036**  
BLACK MATT / NEGRO MATE

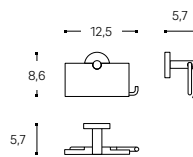

INCH 4.9x2.2x3.4



◎  
VERTICAL PAPER HOLDER  
PORTAPAPEL VERTICAL

**WJC419A0058001**  
CHROME / CROMO  
**WJC419A0058036**  
BLACK MATT / NEGRO MATE

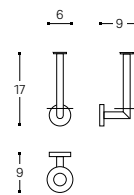

INCH 2.4x3.5x6.7





RIGHT PAPER HOLDER WITHOUT COVER  
PORTAPAPEL SIN TAPA DERECHO

**WJC419A0056001**  
CHROME / CROMO  
**WJC419A0056036**  
BLACK MATT / NEGRO MATE

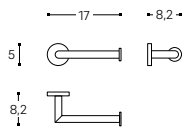

INCH 6.7x3.2x2



DOUBLE PAPER HOLDER  
PORTAPAPEL DOBLE

**WJC419A0055001**  
CHROME / CROMO  
**WJC419A0055036**  
BLACK MATT / NEGRO MATE

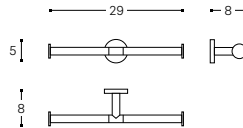

INCH 11.4x3.1x2



WASTE BIN 3L  
PAPELERA 3L

**WJC292A0002003**  
BRUSHED STAINLESS STEEL / INOX CEPILLADO  
**WJC292A0002036**  
BLACK MATT / NEGRO MATE

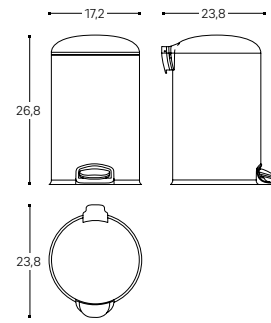

INCH 6.8x9.4x10.5



TOILET BRUSH  
ESCOBILLERO

**WJC419A0000001**  
CHROME / CROMO  
**WJC419A0000036**  
BLACK MATT / NEGRO MATE

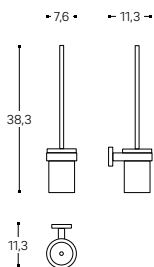

INCH 3x4.4x15.1



TOILET BRUSH  
ESCOBILLERO

**WJC226A0097002**  
GLOSSY INOX / INOX BRILLO  
**WJC226A0097036**  
BLACK MATT / NEGRO MATE

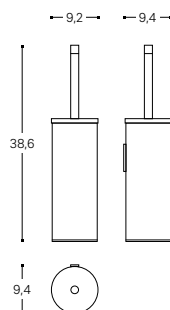

INCH 3.6x3.7x15.2



FREE STANDING TOILET BRUSH  
ESCOBILLERO SUELO

**WJC226A0001002**  
GLOSSY INOX / INOX BRILLO  
**WJC226A0001036**  
BLACK MATT / NEGRO MATE

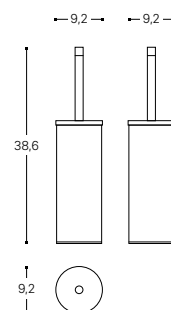

INCH 3.6x3.6x15.2



# L'Avenir

Design by Ricard Ferrer + OiKo



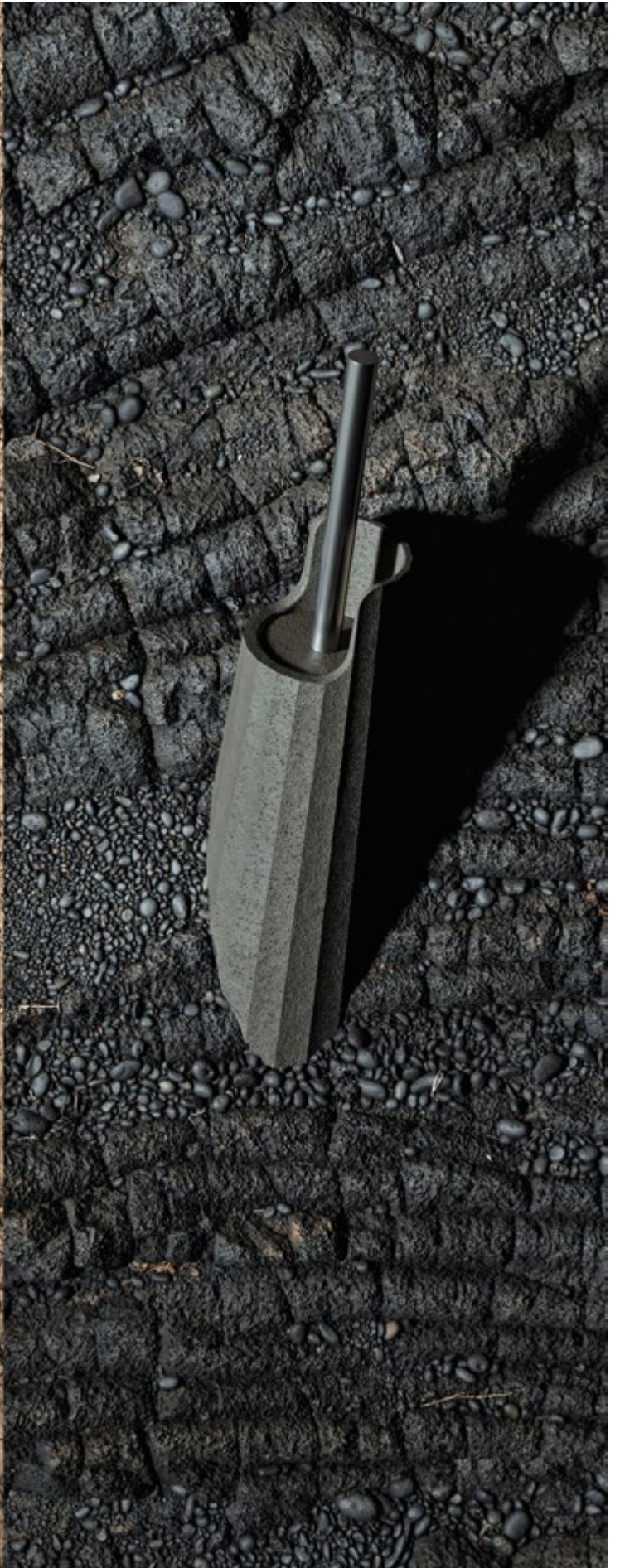

# L'Avenir

Design by Ricard Ferrer + OiKo



**L'Avenir is a collection of accessories by Industrias COSMIC, designed by Ricard Ferrer and developed in conjunction with OiKo Design Office. The use of up to 96% recycled plastics in its production results in the creation of a new material with colours and textures never seen before.**

L'Avenir, es una colección de complementos de COSMIC diseñada por Ricard Ferrer y desarrollada conjuntamente con OiKo design Office. El empleo en su fabricación de hasta un 96% de plásticos reciclados resulta en la creación de un nuevo material con colores y texturas nunca vistos.





L'Avenir introduces a new form of awareness to COSMIC by using recovered materials and textures that redefine the value of objects, calling for a new culture of responsible, sustainable consumption. L'Avenir arose from the need to declare a firm environmental commitment, acknowledging that daily objects should be designed by using materials and resources responsibly, and creating a circle that should be followed and which leads to a balanced future.

L'Avenir introduce en COSMIC, una nueva sensibilidad, a partir de materiales recuperados y texturas que redefinen el valor de los objetos, apelando a una nueva cultura de consumo responsable y sostenible. L'Avenir se plantea desde la necesidad asumir un compromiso firme con el medio ambiente, entendiendo que los objetos cotidianos deben diseñarse haciendo un uso responsable de materiales y recursos, un círculo que debe transitarse y que apunta a un futuro en equilibrio.

# L'Avenir

Design by Ricard Ferrer + OiKo



# A sustainable production process

## Un proceso de producción sostenible

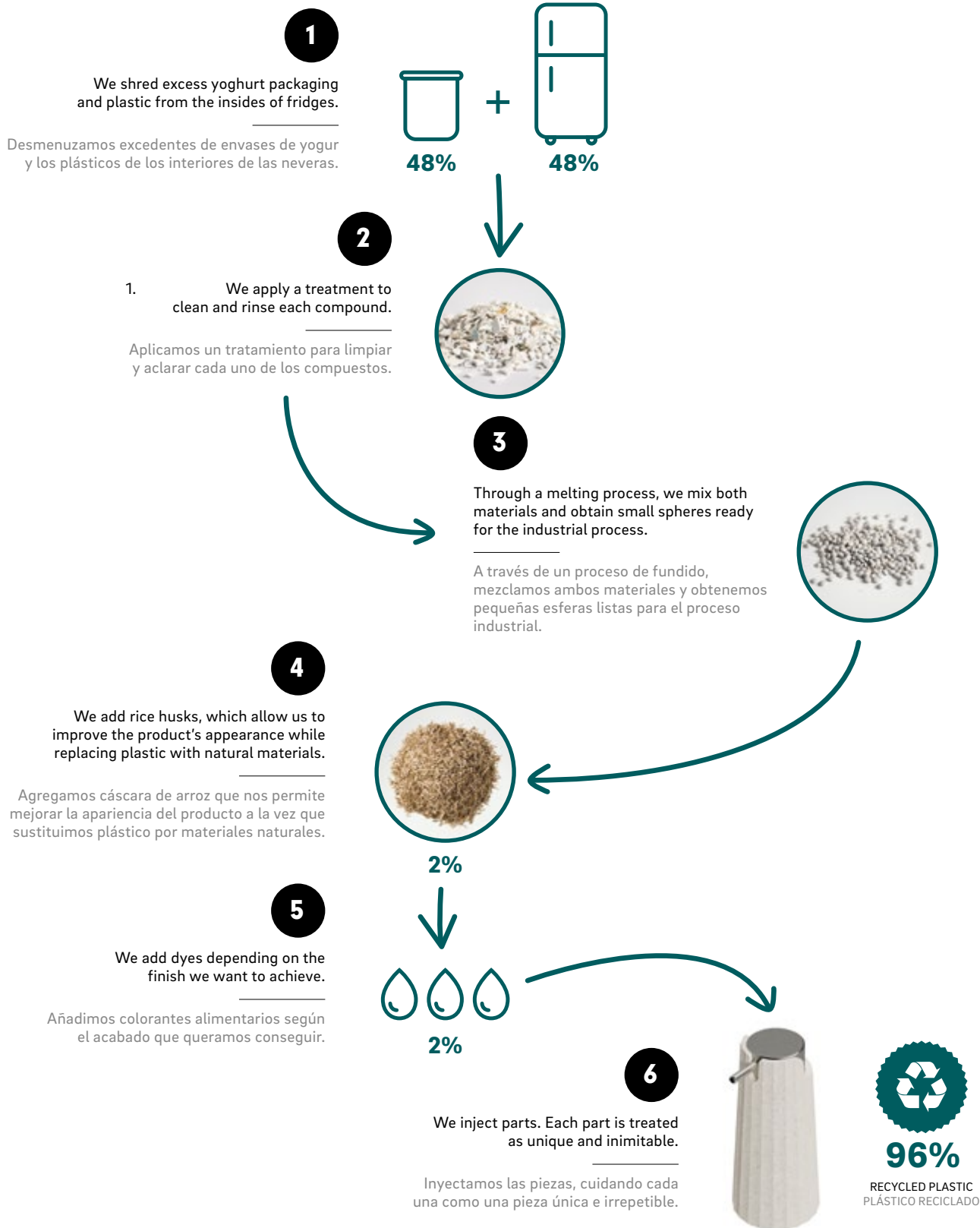



**083**  
SAND NATUR  
BRUSHED GOLD PVD  
ARENA NATUR  
ORO CEPILLADO PVD



**082**  
RUSSET NATUR  
BRUSHED COPPER PVD  
TERRACOTA NATUR  
COBRE CEPILLADO PVD



**081**  
WHITE NATUR  
BRUSHED STEEL  
BLANCO NATUR  
INOX CEPILLADO

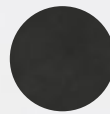

**080**  
BLACK NATUR  
BRUSHED BLACK PVD  
NEGRO NATUR  
NEGRO CEPILLADO PVD





FREE STANDING BRUSH-HOLDER  
PORTACEPILLOS ENCIMERA

- WJC216A0053080**  
BLACK NATUR / NEGRO NATUR
- WJC216A0053081**  
WHITE NATUR / BLANCO NATUR
- WJC216A0053082**  
RUSSET NATUR / TERRACOTA NATUR
- WJC216A0053083**  
SAND NATUR / ARENA NATUR

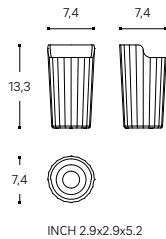

FREE STANDING SOAP DISH  
JABONERA ENCIMERA

- WJC216A0034080**  
BLACK NATUR / NEGRO NATUR
- WJC216A0034081**  
WHITE NATUR / BLANCO NATUR
- WJC216A0034082**  
RUSSET NATUR / TERRACOTA NATUR
- WJC216A0034083**  
SAND NATUR / ARENA NATUR

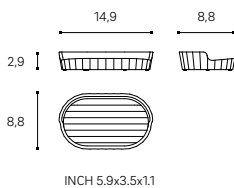

FREE STANDING SOAP DISPENSER 200 ML  
DOSIFICADOR ENCIMERA 200 ML

- WJC216A0004080**  
BLACK NATUR / NEGRO NATUR
- WJC216A0004081**  
WHITE NATUR / BLANCO NATUR
- WJC216A0004082**  
RUSSET NATUR / TERRACOTA NATUR
- WJC216A0004083**  
SAND NATUR / ARENA NATUR

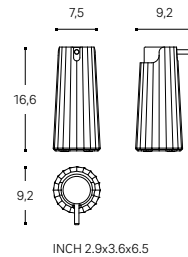

FREE STANDING TOILET BRUSH  
ESCIBILLERO SUELO

- WJC216A0001080**  
BLACK NATUR / NEGRO NATUR
- WJC216A0001081**  
WHITE NATUR / BLANCO NATUR
- WJC216A0001082**  
RUSSET NATUR / TERRACOTA NATUR
- WJC216A0001083**  
SAND NATUR / ARENA NATUR

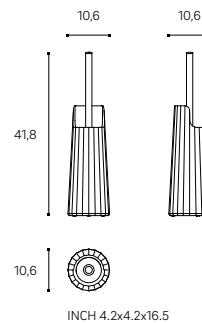





# Essentials

---



# Essentials



**Cosmic is launching its new wall mirror with LED light and an exclusive design based on current market requirements and trends. With two arms to help move it, this mirror can be connected either with a direct power connection or a power cable. It boasts a 5x magnifying feature and both its temperature and power can be adjusted.**

**Cosmic lanza su nuevo espejo de pared con luz LED y diseño exclusivo basado en las necesidades y tendencias del mercado. Con dos brazos para facilitar su maniobrabilidad, puede ir tanto a conexión de potencia directa como vía cable de toma a corriente. Tiene un aumento de x5 y puedes regular tanto la temperatura como la potencia.**



**Essentials** has successfully passed the high demanding tests of long last durability to assure long last durability of the product. All products come with 3 years warranty.

**Essentials** ha superado con éxito exigentes tests de durabilidad para asegurar una larga vida al producto. Todos los artículos tienen 3 años de garantía.



LED lighting  
Luz LED



Touch switch  
Interruptor táctil



Light temperature (colour) adjustable  
Temperatura de luz (color) ajustable



5 x magnification  
Espejo con 5 aumentos

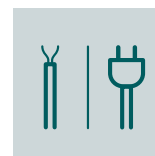

Ground wire or plug in  
Toma directa o enchufe



Double articulated arm and adjustable orientation by means of a ball joint  
Non-reversible  
Doble brazo articulado y orientación regulable mediante rótula  
No reversible

## FINISHES / ACABADOS



**001**  
Chrome  
Cromo



**036**  
Black matt  
Negro mate





WALL MAGNIFYING MIRROR WITH ADJUSTABLE LED LIGHT  
ESPEJO AUMENTO DE PARED CON LUZ LED REGULABLE

IP44

**WJC292A0184001**  
CHROME / CROMO

**WJC292A0184036**  
BLACK MATT / NEGRO MATE

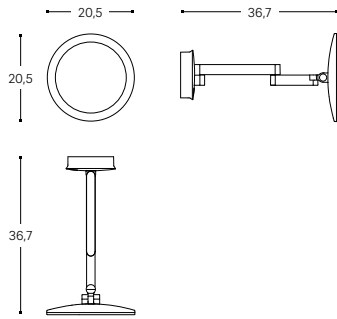

INCH 8.1x14.4x8.1



# Lagoon

Design by **Cosmic Studio**





# Lagoon

Design by Cosmic Studio



**Lagoon is the new collection of furniture, washbasins and mirrors by Cosmic aimed at fans of authenticity. Design originality is as important as the unique nature of Cosmic's values. Lagoon. Eternal and durable.**

**Lagoon es la nueva colección de muebles, lavabos y espejos de Cosmic dirigido a los amantes de lo auténtico. Tan importante es la originalidad del diseño como la singularidad de los valores de Cosmic. Lagoon, eterna y duradera.**

## **HIGH CAPACITY STORAGE**

Under-sink cabinets and the tall cabinet with their distinctive coated handle, allowing for easy opening and closing. The inside of the top drawer has a cut-out for the siphon and an organiser, a solution that allows you to make full use of the space inside bathroom furnishings. There is also personalised detailing on the wood with the Cosmic logo. Interiors in anthracite finish.

## **GRAN CAPACIDAD DE ALMACENAJE**

Los muebles bajo lavabo y el armario alto con su distintivo tirador lacado mate se mimetiza totalmente con el conjunto del mueble y permite una fácil apertura y cierre. El interior del cajón superior dispone de recorte salva sifón y un organizador, una solución para aprovechar el espacio interior de los muebles de baño. Hay que destacar el detalle de madera marcado Cosmic. Interiores en acabado antracita.







#### TALL COLUMN WITH ONE DOOR

Cabinet with extensive storage space and a characteristic front that imitates a delicate thickness of 6 mm.

Door opens to the right or left, non-reversible. It has four thick glass shelves supported by a metal bracket and one fixed wooden shelf that offers the piece stability.

#### COLUMNA ALTA CON UNA PUERTA

Armario con gran espacio de almacenamiento y un frente característico que simula un delicado espesor de 6mm.

La apertura de la puerta puede ser derecha e izquierda, pero no son reversibles. En su interior dispone de 4 estantes de cristal de gran espesor sujetos por una abrazadera metálica y un estante de madera fijo que da estabilidad al conjunto.



#### ROUND-EDGE

The furniture's surface finishes and countertops with built-in washbasins help to increase the perception of comfort, since matte colour coatings and the Solid Surface material of the countertops have a silky texture that is pleasant to the touch.

The exclusive, designer handle blends in perfectly with the piece's organic shapes. Great length and reduced thickness are highlighted by the light when shone on its subtle, frontal groove.

#### CANTOS REDONDEADOS

Los acabados superficiales de los muebles y encimeras con lavabos integrados ayudan a que la percepción de confort sea mayor, ya que los lacados de colores mates y los materiales Solidmat y Gelmat en la encimeras poseen una textura sedosa y agradable al tacto.

El tirador de diseño exclusivo se integra a la perfección con la forma orgánica de la serie. Gran longitud y espesor reducido para una apertura fácil de los cajones y armario.







**The Lagoon collection wins people over with its harmonious composition that marries traditional stylistic guidelines with modern tendencies. The rounded edges and minimal thicknesses of each feature ensure the set is perceived as a cohesive piece that is accommodating and convenient to use given the scarcity of sharp edges. The effect of the light used highlights all of these properties.**

---

La colección Lagoon convence con su composición armónica, que une directrices estilísticas tradicionales y modernas. Los cantos redondeados o romos y los espesores mínimos en cada elemento hacen que el conjunto se perciba como una pieza cohesionada, amable y confortable en su uso por la escasez de aristas vivas, y en el que la luz mediante su incidencia se ocupa de destacar todas estas propiedades.





**This is an extremely versatile collection that offers multiple furnishing combinations with built-in washbasin or countertop basin, and storage options, allowing it to adapt to every requirement.**

**Colección muy versátil que ofrece múltiples combinaciones de muebles con lavabos integrados o lavabos sobre encimera y opciones de almacenaje, para adaptarse a todas las necesidades.**

Construction detail of the fronts, sides, handle and bullnose of the built-in washbasin. Slim fronts, machined with an edge simulating a visible thickness of 6 mm.

Detalle constructivo de los frentes, costados, tirador y canto redondeado o romo del lavabo integrado. Frentes Slim, mecanizados en canto simulando un espesor visto de 6 mm.

## Countertop washbasin | Lavabos de sobre encimera



### WASHBASIN LAGOON SOLIDMAT / LAVABO LAGOON SOLIDMAT



#### SOLIDMAT

The Solid Surface material is a mix formed by the polymerisation of reactive monomers and resins together with a high percentage of natural mineral loads. It features a satin-like, durable finish. This is a fireproof, compact, non-porous, hygienic and strong material. Available in solid matte white.

#### SOLIDMAT

Material Solid Surface, una mezcla formada por la polimerización de resinas y monómeros reactivos junto con un alto porcentaje de cargas minerales naturales. Destaca por su tacto satinado y su durabilidad. Es un material ignífugo, compacto y no poroso, higiénico y resistente. Disponible en blanco mate homogéneo.

### VITREOUS CHINA WASHBASIN LAGOON / LAVABO LAGOON CERÁMICA



#### VITREOUS CHINA

Countertop washbasins made with high-quality glazed ceramics available in three matte colours: white, sand and grey. The mark-free glaze has high chemical resistance and a smooth texture. No overflow.

#### CERÁMICA

Lavabos de sobre encimera fabricados con cerámica esmaltada de alta calidad disponible en 3 colores mate, blanco, arena y gris. Un esmalte de buena resistencia química, libre de manchas y textura lisa. Sin rebosadero.

### VITREOUS CHINA WASHBASIN LAGOON / LAVABO LAGOON CERÁMICA





**Exclusive built-in washbasin with a large interior basin and round edges made in Solid Surface. Built-in click-clack plug made with the same material. Built-in washbasin with overflow.**

---

**Lavabo integrado exclusivo con un gran seno interior y cantos romos fabricado en Solidmat. Válvula click-clack integrada fabricada con el mismo material. Dispone de rebosadero.**



**GELMAT WASHBAIN / LAVABO GELMAT**



**GEL COAT WITH SUPER-MATTE EFFECT**

This is an innovative manufacturing technique that consists of a resin and mineral load compound enriched with an outer gel coat layer. This outer coating grants it a chalk-paint texture and super-matte effect, as well as added durability and resistance. What makes this process innovative is the way the mould is made to obtain a smooth texture free from imperfections. Available in matte sand.

**GELMAT CON TEXTURA SUPER MATE**

Una innovadora técnica de fabricación que consiste en un compuesto de resinas y cargas minerales, enriquecidos con una capa exterior de Gel Coat. Este recubrimiento exterior le confiere textura de pintura a la tiza efecto super mate, aportando un extra de dureza y resistencia. Lo innovador en este proceso consiste en la manera de fabricar el molde para obtener una textura lisa sin imperfecciones. Disponible en color arena mate.

**LAGOON SOLIDMAT WASHBAIN / LAVABO LAGOON SOLIDMAT**



**SOLIDMAT**

The Solid Surface material is a mix formed by the polymerisation of reactive monomers and resins together with a high percentage of natural mineral loads. It features a satin-like, durable finish. This is a fireproof, compact, non-porous, hygienic and strong material. Available in solid matte white.

**SOLIDMAT**

Material Solid Surface, una mezcla formada por la polimerización de resinas y monómeros reactivos junto con un alto porcentaje de cargas minerales naturales. Destaca por su tacto satinado y su durabilidad. Es un material ignífugo, compacto y no poroso, higiénico y resistente. Disponible en blanco mate homogéneo.

**SOLIDMAT WASHBAIN / LAVABO SOLIDMAT**



# Lagoon

Design by Cosmic Studio







Mirrors with ambient LED lighting encapsulated in a neon tube, with an elastic diffuser and invisible LED points to offer more uniform perimeter lighting. Mirror with polished edge and radius of 10 mm following the same rounded design language as the countertops and furniture to achieve a cohesive set.

Espejos con luz led ambiental encapsulada en tubo de neón, con difusor elástico y puntos de led invisibles, ofrece una iluminación perimetral más uniforme. Espejo con canto pulido de radio 10 mm siguiendo el mismo lenguaje de diseño como de las encimeras y mobiliario para conseguir un conjunto cohesionado.



Polished edge and radius of 10 mm  
Canto pulido radio 10 mm



Anti-fog system  
Sistema antivaho



Samsung LED 3000 °K  
Samsung LED 3000 °K



Switch-on sensor  
Sensores de encendido



Switch-off timer  
Temporizador de apagado



Anti-condensation system is switched off after 2 hours of operation  
El antivaho se apaga a las 2 horas de su funcionamiento



Light is switched off after 12 hours of operation  
La luz se apaga a las 12 horas de su funcionamiento

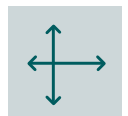

Adjustable wall brackets  
Soportes pared regulables



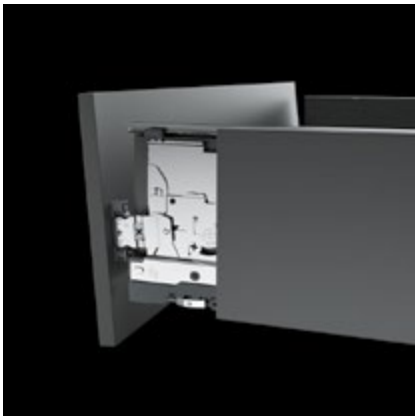

## HETTICH AVANTECH YOU GUIDES

### Exceptional cushioning with gentle closure.

Drawer with Hettich Avantech YOU metal structure, with depth of 400. It can support up to 40 kg of weight and can be fully removed. Soft Close silent closure, which allows adjustment. The adjustment options (height, side and incline) of the Avantech YOU drawer system allows you to perfectly align the fronts.

It has no covers or holes that alter the side's clean, straight finish. The framework remains on a second plane, built into the piece as just another component in its slim design. The outer cover slides. The exclusive sliding mechanism allows the front to be released and adjusted vertically and laterally.

## GUÍAS HETTICH AVANTECH YOU

### Amortiguación excepcional, con cierre suave.

Cajón de costilla metálica Hettich Avantech You, con fondo 400 mm. Aguanta hasta 40 Kg de peso y extracción total. Cierre silencioso Soft Close, que permite regulación. Las opciones de ajuste (altura, lateral e inclinación) del sistema de cajones Avantech YOU permiten crear una alineación de fugas perfecta de los frentes. Sin tapas, ni agujeros que alteren el acabado limpio y recto del costado. El herraje permanece en segundo plano, integrado en el mueble como un elemento más del delgado diseño. La tapa exterior es deslizante. El exclusivo mecanismo de deslizamiento permite soltar el frente y ajustarlo en altura y lateralmente.

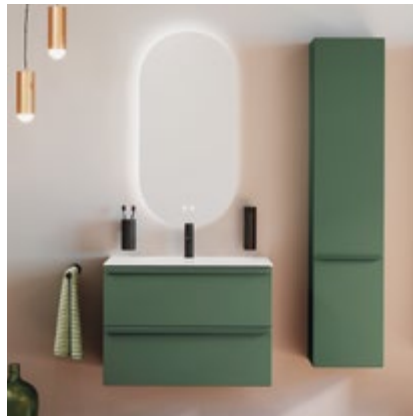

## MDF WOOD

### Round-edge furniture and countertops.

Wooden countertops made in MDF given matte finishes and treated with a high-resistance coating. Of its eight coated finishes, four of them (blue, grey, terracotta and green) are colours developed using waterborne coating processes that are non-toxic and more environmentally friendly. The new Lagoon collection strengthens the company's commitment to sustainability. Under-sink cabinet with two suspended drawers that have edges glued using state-of-the-art thermofusion or PUR (polyurethane reactive) glues, offering improved resistance to humidity given the better seal of the edge.

## MADERA MDF

### Muebles y encimeras de canto romo.

Encimeras de madera fabricadas en MDF lacadas en acabados mate tratadas con un recubrimiento de alta resistencia. De los 8 acabados lacados, 4 de ellos, azul, gris, terracota y verde, son colores desarrollados con procesos de lacado al agua, sin toxicidad y más respetuosos con el medio ambiente. La nueva colección Lagoon refuerza el compromiso de la compañía con la sostenibilidad. Mueble bajo lavabo de 2 cajones suspendido con cantos encolados con colas de termofusión o PUR (poliuretano reactivo) de última generación que aporta mayor resistencia a la humedad, debido al mejor sellado del canto.



Lagoon has successfully passed the high demanding tests of long last durability to assure long last durability of the product. All products come with 5 years warranty.

Lagoon ha superado con éxito exigentes tests de durabilidad para asegurar una larga vida al producto. Todos los artículos tienen 5 años de garantía.



FSC Certified products.

Productos certificados FSC.



FRONT  
FRONTAL



SLIM  
SLIM

STRUCTURE  
ESTRUCTURA



LAMINATE /  
LACQUERED PANEL  
TABLERO  
LAMINADO / LACADO

DRAWERS  
CAJONES



COMPLETE  
EXTENSION  
EXTENSION  
COMPLETA



SOFT-CLOSE  
SYSTEM  
SISTEMA  
SOFT-CLOSE

WASHBASINS  
LAVABOS



BUILT IN  
INTEGRADO



COUNTERTOP  
SOBRE-ENCIMERA

Wooden furniture and countertop | Muebles y encimeras de madera

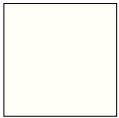

**102**  
MATT WHITE  
BLANCO MATE



**766**  
MATT SAND  
ARENA MATE



**116**  
MATT GREEN  
VERDE MATE



**122**  
MATT PINK  
ROSA MATE



**126**  
MATT BLUE  
AZUL MATE



**768**  
MATT RUSSET  
TERRACOTA MATE



**767**  
MATT GREY  
GRIS MATE



**535**  
MATT ANTHRACITE  
ANTRACITA MATE



Handles | Tiradores



**102**  
MATT WHITE  
BLANCO MATE



**766**  
MATT SAND  
ARENA MATE



**116**  
MATT GREEN  
VERDE MATE



**122**  
MATT PINK  
ROSA MATE



**535**  
MATT ANTHRACITE  
ANTRACITA MATE

Solidmat: built in washbasins, vanity tops and countertop washbasins  
Solidmat: lavabos integrados, encimeras y lavabos de sobre encimera

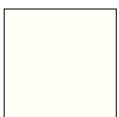

**102**  
MATT WHITE  
BLANCO MATE

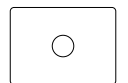
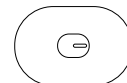
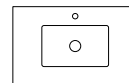
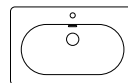

Gelmat: built in washbasins and countertop  
Gelmat: lavabos integrados y encimeras



**766**  
MATT SAND  
ARENA MATE

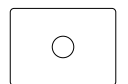
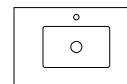

Vitreous china: over counter top washbasins  
Cerámica: lavabos de sobre encimera

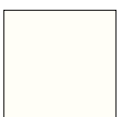

**102**  
MATT WHITE  
BLANCO MATE



**766**  
MATT SAND  
ARENA MATE



**767**  
MATT GREY  
GRIS MATE

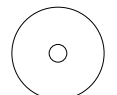
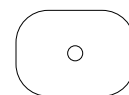



## 2 DRAWERS CABINET MUEBLE 2 CAJONES

FOR WASHBASIN  
PARA LAVABO



**WJC781M0001** \_\_\_  
60 CM

**WJC781M0002** \_\_\_  
80 CM

**WJC781M0003** \_\_\_  
100 CM

**WJC781M0004** \_\_\_  
120 CM

## HANDLE TIRADOR

FOR CABINET (X2)  
PARA MUEBLE (X2)



**WJC781M0045** \_\_\_  
60 CM

**WJC781M0046** \_\_\_  
80 CM

**WJC781M0047** \_\_\_  
100 CM

**WJC781M0048** \_\_\_  
120 CM

## BUILT-IN WASHBAIN LAVABO INTEGRADO

WASHBAIN LAGOON (SOLIDMAT)\*  
LAVABO LAGOON (SOLIDMAT)\*

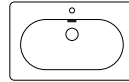

**WJC781M0008102**  
60 CM

**WJC781M0009102**  
80 CM

**WJC781M0010102**  
100 CM

**WJC781M0011102**  
120 CM

## BUILT-IN WASHBAIN LAVABO INTEGRADO

WASHBAIN (SOLIDMAT)\*  
LAVABO (SOLIDMAT)\*

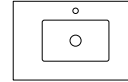

**WJC781M0012102**  
60 CM

**WJC781M0013102**  
80 CM

**WJC781M0014102**  
100 CM

**WJC781M0015102**  
120 CM

FOR RIGHT WASHBASIN  
PARA LAVABO DERECHO

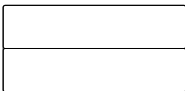

**WJC781M0005** \_\_\_  
120 CM

FOR CABINET (X2)  
PARA MUEBLE (X2)



**WJC781M0048** \_\_\_  
120 CM

RIGHT WASHBASIN (SOLIDMAT)\*  
LAVABO DERECHA (SOLIDMAT)\*

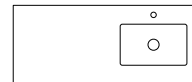

**WJC781M0016102**  
120 CM

FOR LEFT WASHBASIN  
PARA LAVABO IZQUIERDA



**WJC781M0006** \_\_\_  
120 CM

FOR CABINET (X2)  
PARA MUEBLE (X2)



**WJC781M0048** \_\_\_  
120 CM

LEFT WASHBASIN (SOLIDMAT)\*  
LAVABO IZQUIERDA (SOLIDMAT)\*

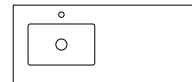

**WJC781M0017102**  
120 CM

FOR DOUBLE WASHBASIN  
PARA LAVABO DOBLE



**WJC781M0001** \_\_\_ (x2)  
60 CM

FOR CABINET (X2)  
PARA MUEBLE (X2)



**WJC781M0045** \_\_\_ (x2)  
60 CM

DOUBLE WASHBASIN (SOLIDMAT)\*  
LAVABO DOBLE (SOLIDMAT)\*

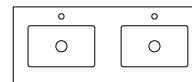

**WJC781M0058102**  
120 CM

FOR DOUBLE WASHBASIN  
PARA LAVABO DOBLE



**WJC781M0002** \_\_\_ (x2)  
80 CM

FOR CABINET (X2)  
PARA MUEBLE (X2)



**WJC781M0046** \_\_\_ (x2)  
80 CM

FURNITURE FINISHES  
ACABADOS MUEBLES



HANDLE FINISHES  
ACABADOS TIRADORES



WASHBAIN FINISHES  
ACABADO LAVABO



WASHBAIN FINISHES  
ACABADO LAVABO



INCLUDED



INCLUDED



R10 MM



NOT INCLUDED



NOT INCLUDED



90°



VALVE  
VÁLVULA



OVERFLOW  
ESCOADOURO

\* AVAILABLE, UNDER ORDER, WITHOUT HOLE FOR FAUCETS.  
\* DISPONIBLES, BAJO PEDIDO, SIN AGUJERO PARA GRIFERÍA.

# Selection matrix | Matriz de selección

## BUILT-IN WASHBAIN LAVABO INTEGRADO

### WASHBAIN (GELMAT)\* LAVABO (GELMAT)\*

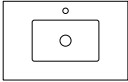

**WJC781M0018766**  
60 CM

**WJC781M0019766**  
80 CM

**WJC781M0020766**  
100 CM

**WJC781M0021766**  
120 CM

### RIGHT WASHBAIN (SOLIDMAT)\* LAVABO DERECHA (SOLIDMAT)\*



**WJC781M0022766**  
120 CM

### LEFT WASHBAIN (SOLIDMAT)\* LAVABO IZQUIERDA (SOLIDMAT)\*



**WJC781M0023766**  
120 CM

### WASHBAIN FINISHES ACABADO LAVABO



NOT INCLUDED



NOT INCLUDED



90°

## COUNTERTOP ENCIMERA

### COUNTERTOP (SOLIDMAT) ENCIMERA (SOLIDMAT)

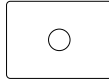

**WJC781M0024102**  
60 CM

**WJC781M0025102**  
80 CM

**WJC781M0026102**  
100 CM

**WJC781M0027102**  
120 CM

### RIGHT COUNTERTOP (SOLIDMAT) ENCIMERA DERECHA (SOLIDMAT)



**WJC781M0028102**  
120 CM

### LEFT COUNTERTOP (SOLIDMAT) ENCIMERA IZQUIERDA (SOLIDMAT)



**WJC781M0029102**  
120 CM

### DOUBLE COUNTERTOP (SOLIDMAT) ENCIMERA DOBLE (SOLIDMAT)

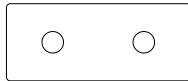

**WJC781M0059102**  
120 CM

### DOUBLE COUNTERTOP (SOLIDMAT) ENCIMERA DOBLE (SOLIDMAT)



**WJC781M0068102**  
160 CM

### COUNTERTOP FINISHES ACABADO ENCIMERA



R10 MM

## COUNTERTOP ENCIMERA

### COUNTERTOP (GELMAT) ENCIMERA (GELMAT)

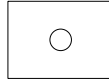

**WJC781M0030766**  
60 CM

**WJC781M0031766**  
80 CM

**WJC781M0032766**  
100 CM

**WJC781M0033766**  
120 CM

### RIGHT COUNTERTOP (GELMAT) ENCIMERA DERECHA (GELMAT)



**WJC781M0034766**  
120 CM

### LEFT COUNTERTOP (GELMAT) ENCIMERA IZQUIERDA (GELMAT)



**WJC781M0035766**  
120 CM

### COUNTERTOP FINISHES ACABADO ENCIMERA



90°

## COUNTERTOP ENCIMERA

### COUNTERTOP (MDF) ENCIMERA (MDF)

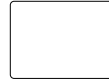

**WJC781M0036\_\_\_**  
60 CM

**WJC781M0037\_\_\_**  
80 CM

**WJC781M0038\_\_\_**  
100 CM

**WJC781M0039\_\_\_**  
120 CM

### COUNTERTOP FINISHES ACABADO ENCIMERA



R10 MM





2 DRAWERS CABINET FOR WASHBASIN 60 CM  
MUEBLE 2 CAJONES PARA LAVABO 60 CM

**WJC781M0001102**  
**WJC781M0001766**  
**WJC781M0001\_ \_ \_**

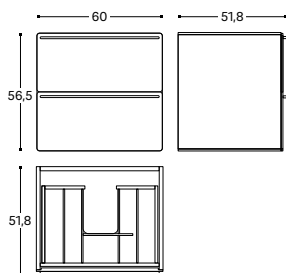

INCH 23.6x20.4x22.2



2 DRAWERS CABINET FOR WASHBASIN 80 CM  
MUEBLE 2 CAJONES PARA LAVABO 80 CM

**WJC781M0002102**  
**WJC781M0002766**  
**WJC781M0002\_ \_ \_**

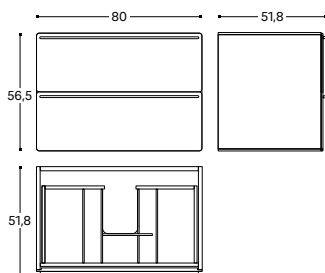

INCH 31.5x20.4x22.2



2 DRAWERS CABINET FOR WASHBASIN 100 CM  
MUEBLE 2 CAJONES PARA LAVABO 100 CM

**WJC781M0003102**  
**WJC781M0003766**  
**WJC781M0003\_ \_ \_**

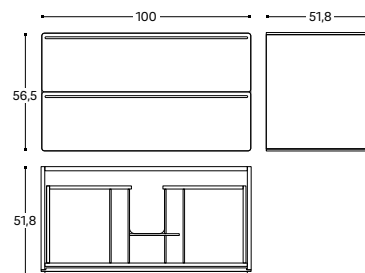

INCH 39.4x20.4x22.2



2 DRAWERS CABINET FOR WASHBASIN 120 CM  
MUEBLE 2 CAJONES PARA LAVABO 120 CM

**WJC781M0004102**  
**WJC781M0004766**  
**WJC781M0004\_ \_ \_**

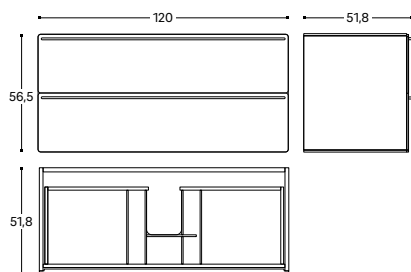

INCH 47.2x20.4x22.2



2 DRAWERS CABINET FOR WASHBASIN RIGHT 120 CM  
MUEBLE 2 CAJONES PARA LAVABO DERECHO 120 CM

**WJC781M0005102**  
**WJC781M0005766**  
**WJC781M0005\_ \_ \_**

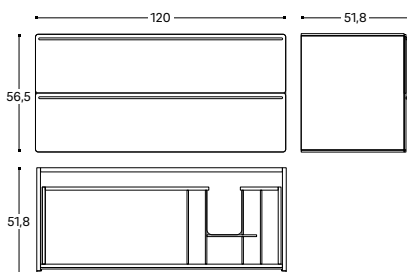

INCH 47.2x20.4x22.2



2 DRAWERS CABINET FOR WASHBASIN LEFT 120 CM  
MUEBLE 2 CAJONES PARA LAVABO IZQUIERDO 120 CM

**WJC781M0006102**  
**WJC781M0006766**  
**WJC781M0006\_ \_ \_**

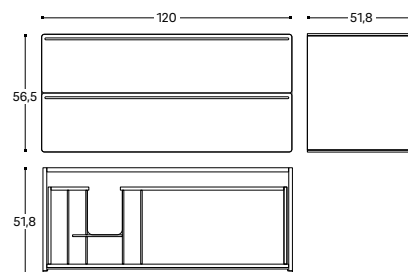

INCH 47.2x20.4x22.2





COLUMN-RIGHT DOOR  
COLUMNA DERECHA

**WJC781M0007102**  
**WJC781M0007766**  
**WJC781M0007...**

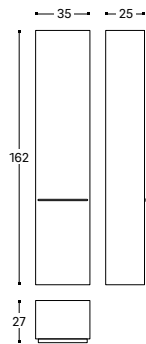

INCH 13.8x9.8x63.8



COLUMN-LEFT DOOR  
COLUMNA IZQUIERDA

**WJC781M0057102**  
**WJC781M0057766**  
**WJC781M0057...**

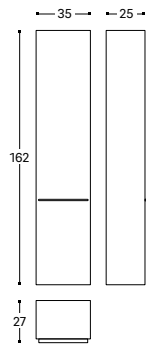

INCH 13.8x9.8x63.8



COLUMN HANDLE  
TIRADOR COLUMNA

**WJC781M0049535**  
MATT ANTHRACITE / ANTRACITA MATE  
**WJC781M0049766**  
MATT SAND / ARENA MATE  
**WJC781M0049102**  
MATT WHITE / BLANCO MATE  
**WJC781M0049122**  
MATT PINK / ROSA MATE  
**WJC781M0049116**  
MATT GREEN / VERDE MATE

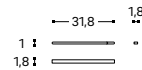

INCH 12.5x0.7x0.4



CABINET HANDLE 60 CM (X2)  
TIRADOR MUEBLE 60 CM (X2)

**WJC781M0045535**  
MATT ANTHRACITE / ANTRACITA MATE  
**WJC781M0045766**  
MATT SAND / ARENA MATE  
**WJC781M0045102**  
MATT WHITE / BLANCO MATE  
**WJC781M0045122**  
MATT PINK / ROSA MATE  
**WJC781M0045116**  
MATT GREEN / VERDE MATE

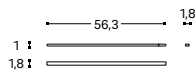

INCH 22.2x0.7x0.4



CABINET HANDLE 80 CM (X2)  
TIRADOR MUEBLE 80 CM (X2)

**WJC781M0046535**  
MATT ANTHRACITE / ANTRACITA MATE  
**WJC781M0046766**  
MATT SAND / ARENA MATE  
**WJC781M0046102**  
MATT WHITE / BLANCO MATE  
**WJC781M0046122**  
MATT PINK / ROSA MATE  
**WJC781M0046116**  
MATT GREEN / VERDE MATE

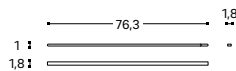

INCH 30x0.7x0.4



CABINET HANDLE 100 CM (X2)  
TIRADOR MUEBLE 100 CM (X2)

**WJC781M0047535**  
MATT ANTHRACITE / ANTRACITA MATE  
**WJC781M0047766**  
MATT SAND / ARENA MATE  
**WJC781M0047102**  
MATT WHITE / BLANCO MATE  
**WJC781M0047122**  
MATT PINK / ROSA MATE  
**WJC781M0047116**  
MATT GREEN / VERDE MATE

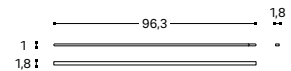

INCH 37.9x0.7x0.4



# Lagoon

Design by Cosmic Studio



●  
CABINET HANDLE 120 CM (X2)  
TIRADOR MUEBLE 120 CM (X2)

- WJC781M0048535**  
MATT ANTHRACITE / ANTRACITA MATE
- WJC781M0048766**  
MATT SAND / ARENA MATE
- WJC781M0048102**  
MATT WHITE / BLANCO MATE
- WJC781M0048122**  
MATT PINK / ROSA MATE
- WJC781M0048116**  
MATT GREEN / VERDE MATE

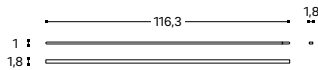

INCH 45.8x0.7x0.4



●  
BUILT-IN WASHBAIN LAGOON (SOLIDMAT)\*  
LAVABO INTEGRADO LAGOON (SOLIDMAT)\*

- WJC781M0008102**  
60 CM MATT WHITE / BLANCO MATE
- WJC781M0009102**  
80 CM MATT WHITE / BLANCO MATE
- WJC781M0010102**  
100 CM MATT WHITE / BLANCO MATE
- WJC781M0011102**  
120 CM MATT WHITE / BLANCO MATE

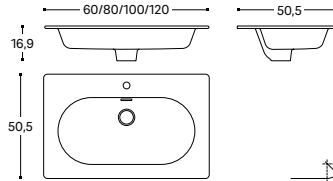

INCH 23.6/31.5/39.4/47.2x19.9x6.6

R10 MM



●  
BUILT-IN WASHBAIN (SOLIDMAT)\*  
LAVABO INTEGRADO (SOLIDMAT)\*

- WJC781M0012102**  
60 CM MATT WHITE / BLANCO MATE
- WJC781M0013102**  
80 CM MATT WHITE / BLANCO MATE
- WJC781M0014102**  
100 CM MATT WHITE / BLANCO MATE
- WJC781M0015102**  
120 CM MATT WHITE / BLANCO MATE

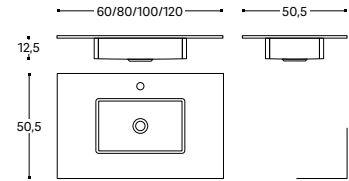

INCH 23.6/31.5/39.4/47.2x19.9x4.9

90°



●  
BUILT-IN WASHBAIN RIGHT (SOLIDMAT)\*  
LAVABO INTEGRADO DERECHA (SOLIDMAT)\*

- WJC781M0016102**  
120 CM MATT WHITE / BLANCO MATE

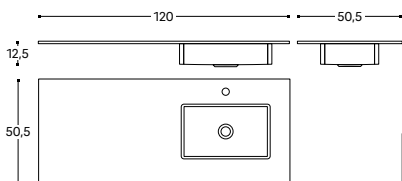

INCH 47.2x19.9x4.9

90°



●  
BUILT-IN WASHBAIN LEFT (SOLIDMAT)\*  
LAVABO INTEGRADO IZQUIERDA (SOLIDMAT)\*

- WJC781M0017102**  
120 CM MATT WHITE / BLANCO MATE

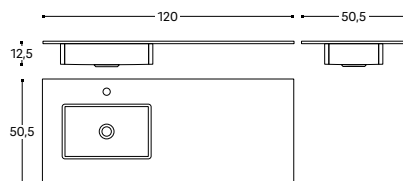

INCH 47.2x19.9x4.9

90°



●  
BUILT-IN WASHBAIN DOUBLE (SOLIDMAT)\*  
LAVABO INTEGRADO DOBLE (SOLIDMAT)\*

- WJC781M0058102**  
120 CM MATT WHITE / BLANCO MATE

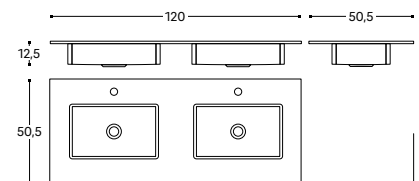

INCH 47.2x19.9x4.9

90°





Ⓐ

**BUILT-IN WASHBAIN (GELMAT)\***  
LAVABO INTEGRADO (GELMAT)\*

- WJC781M0018766**  
60 CM MATT SAND / ARENA MATE
- WJC781M0019766**  
80 CM MATT SAND / ARENA MATE
- WJC781M0020766**  
100 CM MATT SAND / ARENA MATE
- WJC781M0021766**  
120 CM MATT SAND / ARENA MATE

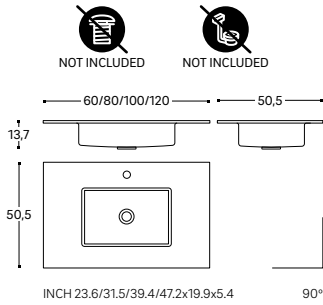

Ⓐ

**BUILT-IN WASHBAIN RIGHT 120 CM (GELMAT)\***  
LAVABO INTEGRADO DERECHA 120 CM (GELMAT)\*

- WJC781M0022766**  
MATT SAND / ARENA MATE

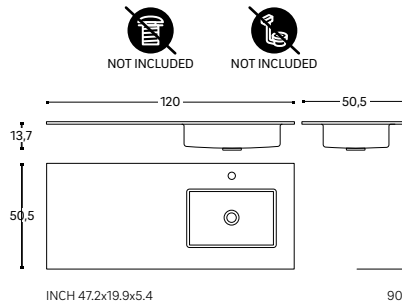

Ⓐ

**BUILT-IN WASHBAIN LEFT 120 CM (GELMAT)\***  
LAVABO INTEGRADO IZQUIERDA 120 CM (GELMAT)\*

- WJC781M0023766**  
MATT SAND / ARENA MATE

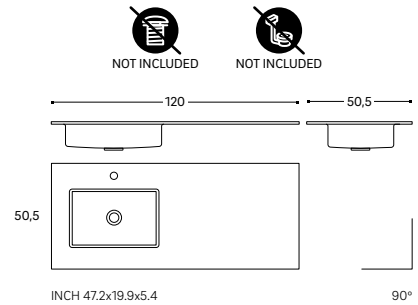

Ⓐ

**COUNTERTOP WASHBAIN LAGOON (SOLIDMAT)**  
LAVABO SOBRE ENCIMERA LAGOON (SOLIDMAT)

- WJC781M0042102**  
MATT WHITE / BLANCO MATE

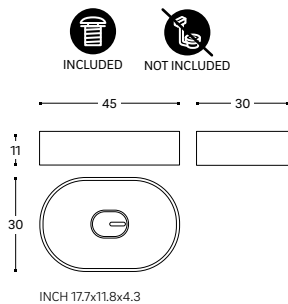

Ⓢ

**RECTANGLE COUNTER TOP WASHBAIN (VITREOUS CHINA)**  
LAVABO SOBRE ENCIMERA RECTANGULAR (CERÁMICA)

- WJC781M0043102**  
MATT WHITE / BLANCO MATE
- WJC781M0043766**  
MATT SAND / ARENA MATE
- WJC781M0043767**  
MATT GREY / GRIS MATE

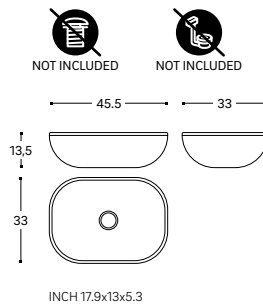

Ⓢ

**ROUND COUNTERTOP WASHBAIN (VITREOUS CHINA)**  
LAVABO SOBRE ENCIMERA REDONDO (CERÁMICA)

- WJC781M0044102**  
MATT WHITE / BLANCO MATE
- WJC781M0044766**  
MATT SAND / ARENA MATE
- WJC781M0044767**  
MATT GREY / GRIS MATE

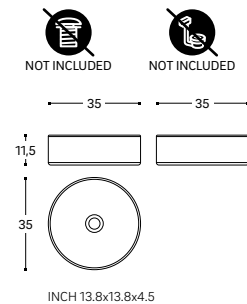



Ⓐ  
**COUNTERTOP (SOLIDMAT)**  
 ENCIMERA (SOLIDMAT)

- WJC781M0024102**  
60 CM MATT WHITE / BLANCO MATE
- WJC781M0025102**  
80 CM MATT WHITE / BLANCO MATE
- WJC781M0026102**  
100 CM MATT WHITE / BLANCO MATE
- WJC781M0027102**  
120 CM MATT WHITE / BLANCO MATE

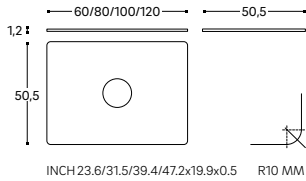

Ⓐ  
**COUNTERTOP RIGHT 120 CM (SOLIDMAT)**  
 ENCIMERA DERECHA 120 CM (SOLIDMAT)

- WJC781M0028102**  
MATT WHITE / BLANCO MATE

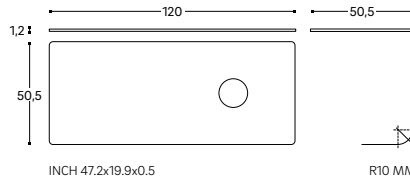

Ⓐ  
**COUNTERTOP LEFT 120 CM (SOLIDMAT)**  
 ENCIMERA IZQUIERDA 120 CM (SOLIDMAT)

- WJC781M0029102**  
MATT WHITE / BLANCO MATE

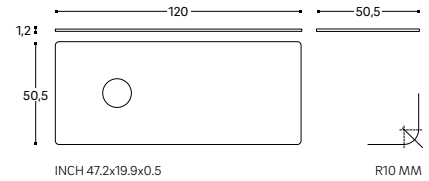

Ⓐ  
**COUNTERTOP DOUBLE (SOLIDMAT)**  
 ENCIMERA DOBLE (SOLIDMAT)

- WJC781M0059102**  
120 CM MATT WHITE / BLANCO MATE
- WJC781M0068102**  
160 CM MATT WHITE / BLANCO MATE

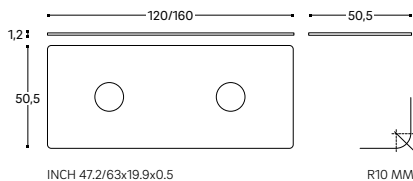

Ⓐ  
**COUNTERTOP (GELMAT)**  
 ENCIMERA (GELMAT)

- WJC781M0030766**  
60 CM MATT SAND / ARENA MATE
- WJC781M0031766**  
80 CM MATT SAND / ARENA MATE
- WJC781M0032766**  
100 CM MATT SAND / ARENA MATE
- WJC781M0033766**  
120 CM MATT SAND / ARENA MATE

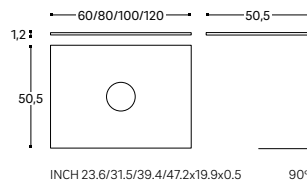

Ⓐ  
**COUNTERTOP RIGHT 120 CM (GELMAT)**  
 ENCIMERA DERECHA 120 CM (GELMAT)

- WJC781M0034766**  
MATT SAND / ARENA MATE

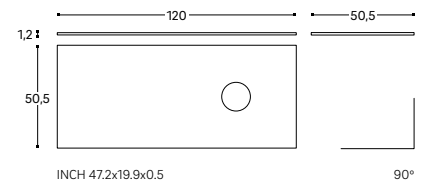



102



766



116



122



126



768



767



535



COUNTERTOP LEFT 120 CM (GELMAT)  
ENCIMERA IZQUIERDA 120 CM (GELMAT)

**WJC781M0035766**  
MATT SAND / ARENA MATE

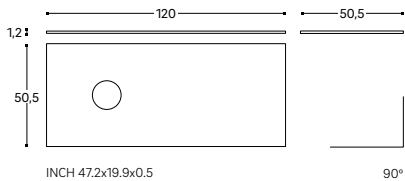

INCH 47.2x19.9x0.5

90°



COUNTERTOP (MDF)  
ENCIMERA (MDF)

**WJC781M0036** ---  
60 CM  
**WJC781M0037** ---  
80 CM  
**WJC781M0038** ---  
100 CM  
**WJC781M0039** ---  
120 CM

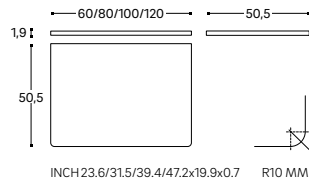

INCH 23.6/31.5/39.4/47.2x19.9x0.7 R10 MM



POP-UP VALVE LAGOON (SOLIDMAT)  
VÁLVULA CLICK-CLACK LAGOON (SOLIDMAT)

**WJC781M0055102**  
MATT WHITE / BLANCO MATE

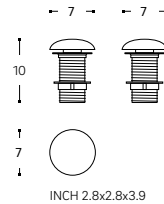

INCH 2.8x2.8x3.9



POP-UP VALVE LAGOON (VITREOUS CHINA)  
VÁLVULA CLICK-CLACK LAGOON (CERÁMICA)

**WJC781M0056766**  
MATT SAND / ARENA MATE

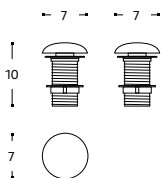

INCH 2.8x2.8x3.9



POP-UP VALVE  
VÁLVULA CLICK CLACK

**WJC341R0387000**  
CHROME / CROMO

**WJC341R0789000**  
MATTE WHITE / BLANCO MATE

**WJC341R0790000**  
MATTE BLACK / NEGRO MATE

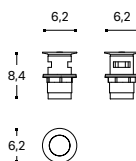

INCH 2.4x2.4x3.3



FREE DRAIN VALVE  
VÁLVULA DESCARGA LIBRE

**WJC341R7600000**  
CHROME / CROMO

**WJC341R0786000**  
MATTE WHITE / BLANCO MATE

**WJC341R0787000**  
MATTE BLACK / NEGRO MATE

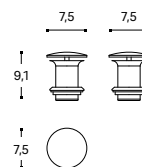

INCH 2.9x2.9x3.6





AMBIENT LED LIGHTING MIRROR  
ESPEJO CON LUZ LED AMBIENTE  
IP44

- WJC781M0064000**  
60 CM / INCH 23.6
- WJC781M0065000**  
80 CM / INCH 31.5
- WJC781M0066000**  
100 CM / INCH 39.4

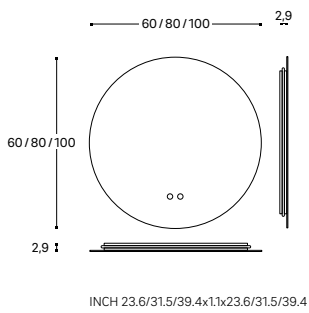

See all characteristics on page 073  
Ver todas las características en la pág.073



AMBIENT LED LIGHTING MIRROR  
ESPEJO CON LUZ LED AMBIENTE  
IP44

- WJC781M0060000**  
60 CM / INCH 23.6
- WJC781M0061000**  
80 CM / INCH 31.5
- WJC781M0062000**  
100 CM / INCH 39.4
- WJC781M0063000**  
120 CM / INCH 47.2

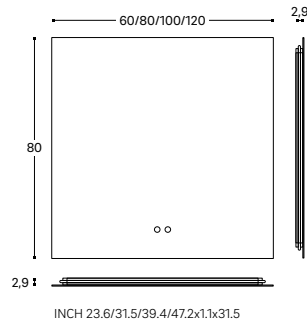

See all characteristics on page 073  
Ver todas las características en la pág.073



AMBIENT LED LIGHTING MIRROR  
ESPEJO CON LUZ LED AMBIENTE  
IP44

- WJC781M0067000**  
50 CM / INCH 19.7

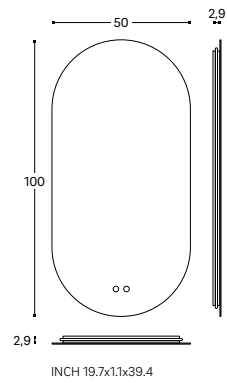

See all characteristics on page 073  
Ver todas las características en la pág.073





**Recommended accesories Micra and Geyser**  
Recomendamos accesorios Micra y Geyser



# Architect

Design by Cosmic Studio





# Architect

Design by Cosmic Studio







Architect: minimalist fittings for a modern bathroom. Their refined design with basic and rounded lines ensures a timelessness and universality. A full bathroom fitting solution to be combined with Cosmic furniture, washbasins, mirrors and screens.

Architect, grifería minimalista para un baño moderno. Su diseño depurado, con líneas básicas y redondeadas, garantizan atemporalidad y universalidad. Solución completa de grifería para combinar con muebles, lavabos, espejos y mamparas Cosmic.



#### **SINGLE-LEVER WASHBASIN MIXER**

Single-lever washbasin mixer with cold start.  
Features a 5 l/min flow limiter.  
Taps with no pop-up drain rod.  
"Made with alloys included in the 'European Positive List' (for non-migration of materials hazardous to water)".  
Cartridge of ceramic discs  $\varnothing 35$  mm.  
Includes flexible supply connections of 3/8".

#### **3F SQUARE SHOWER HOSE**

With three functions: Massage, Rain, Soft.

#### **THERMOSTATIC SHOWER MIXER**

Includes 38°C SafeStop safety device. Bathroom fittings with cold-touch technology to avoid burns. Built into the thermostat and thermal covering of their parts, they ensure no burns are caused when they are touched.

#### **3F SQUARE SHOWER KIT**

Includes: Shower bar. Shower hose of 12x12 cm with three functions: Massage, Rain, Soft. Flexion of 170 cm. Sliding support.

#### **THERMOSTATIC SHOWER COLUMN**

Includes: Sprinkler of 22 cm. Extendible shower bar of 30 cm. Flexion of 170 cm. Shower hose  $\varnothing 10$  cm. One function.  
Built-in shower hose bracket.  
Includes 38°C SafeStop safety device. Bathroom fittings with cold-touch technology to avoid burns. Built into the thermostat and thermal covering of their parts, they ensure no burns are caused when they are touched.

#### **MONOMANDO LAVABO**

Mezclador monomando con apertura en frío. Incorpora limitador de caudal a 5 l/min. Grifos sin varilla de drenaje pop up.  
Fabricado con aleaciones incluidas en la "European Positive List" (para la no migración de materiales peligrosos al agua)".  
Cartucho de discos cerámicos de  $\varnothing 35$  mm.  
Incluye enlaces de alimentación flexible de 3/8".

#### **DUCHA DE MANO 3F SQUARE**

Incorpora 3 funciones: Massage, Rain, Soft.

#### **MEZCLADOR TERMOSTÁTICO PARA DUCHA**

Incluye dispositivo de seguridad 38°C SafeStop. Grifería con tecnología cold-touch para evitar quemaduras. Incorporada en el termostato y el recubrimiento térmico de sus piezas, evitan para siempre las quemaduras al tocar el grifo.

#### **KIT DUCHA 3F SQUARE**

Incluye: Barra de ducha. Ducha de mano de 12x12 cm con 3 funciones: Massage, Rain, Soft. Flexo de 170 cm. Soporte deslizante.

#### **COLUMNA DE DUCHA TERMOSTÁTICA**

Incluye: Rociador de 22 cm. Barra de ducha extensible 30 cm. Flexo de 170 cm. Ducha de mano de  $\varnothing 10$  cm. 1 función. Soporte para ducha de mano integrado.

Incluye dispositivo de seguridad 38°C SafeStop. Grifería con tecnología cold-touch para evitar quemaduras. Incorporada en el termostato y el recubrimiento térmico de sus piezas, evitan para siempre las quemaduras al tocar el grifo.





⊙  
 SINGLE LEVER WASH-BASIN MIXER  
 MONOMANDO LAVABO

**WJC205G0001001**  
 CHROME / CROMO  
**WJC205G0001036**  
 MATT BLACK / NEGRO MATE

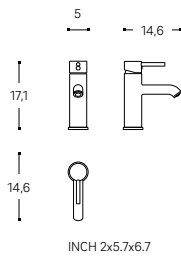

⊙  
 SINGLE LEVER WASH-BASIN MIXER WITH HIGH SPOUT  
 MONOMANDO LAVABO CON CAÑO ALTO

**WJC205G0002001**  
 CHROME / CROMO  
**WJC205G0002036**  
 MATT BLACK / NEGRO MATE

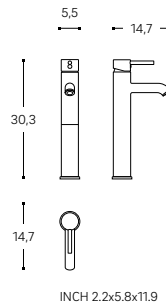

⊙  
 SINGLE LEVER BIDET MIXER  
 MONOMANDO BIDE

**WJC205G0004001**  
 CHROME / CROMO

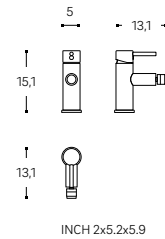

⊙  
 SINGLE LEVER SHOWER MIXER  
 MONOMANDO DUCHA

**WJC205G0007001**  
 CHROME / CROMO  
**WJC205G0007036**  
 MATT BLACK / NEGRO MATE

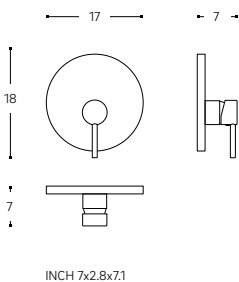

⊙  
 SINGLE LEVER BATH-SHOWER MIXER  
 MONOMANDO DUCHA-BAÑERA

**WJC205G0008001**  
 CHROME / CROMO  
**WJC205G0008036**  
 MATT BLACK / NEGRO MATE

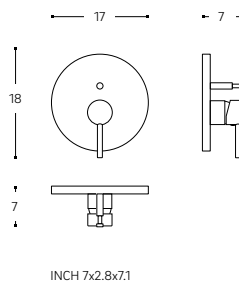

⊙△  
 THERMOSTATIC SHOWER MIXER <sup>(1)</sup>  
 MEZCLADOR TERMOSTÁTICO PARA DUCHA <sup>(1)</sup>

**WJC205G0011001**  
 CHROME / CROMO

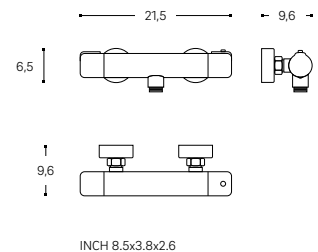

(1) Includes SafeStop safety device at 38°C. Faucet with cold-touch technology to prevent burns. Incorporated in the thermostat and the thermal coating of its parts, it eliminates burns forever when touching the tap.

(1) Incluye dispositivo de seguridad 38°C SafeStop. Grifería con tecnología cold-touch para evitar quemaduras. Incorporado en el termostato y el recubrimiento térmico de sus piezas, evitan para siempre las quemaduras al tocar el grifo.





SHOWER HEAD 3F  
DUCHA DE MANO 3F

**WJC205G0009001**  
CHROME / CROMO  
**WJC205G0009036**  
MATT BLACK / NEGRO MATE

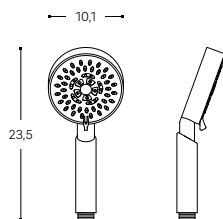

INCH 4x9.2



HAND SHOWER 3F SQUARE (2)  
DUCHA DE MANO 3F SQUARE (2)

**WJC205G0012001**  
CHROME / CROMO  
**WJC205G0012036**  
MATT BLACK / NEGRO MATE

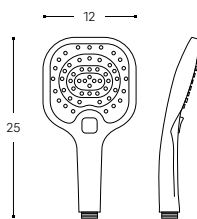

INCH 4.7x9.8



SHOWER KIT 3F SQUARE (2)(3)  
KIT DUCHA 3F SQUARE (2)(3)

**WJC205G0014001**  
CHROME / CROMO

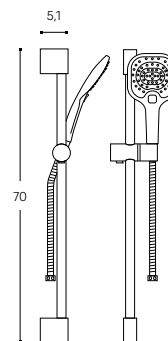

INCH 2x27.6



SHOWER KIT 3F SQUARE (2)(3)  
KIT DUCHA 3F SQUARE (2)(3)

**WJC205G0014036**  
MATT BLACK / NEGRO MATE

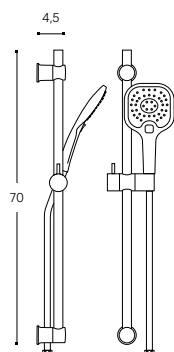

INCH 1.8x27.6



THERMOSTATIC SHOWER COLUMN (1)(4)  
COLUMNA DE DUCHA TERMOSTÁTICA (1)(4)

**WJC205G0015001**  
CHROME / CROMO

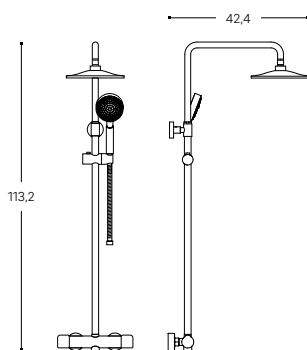

INCH 16.7x44.6



WALL ARM FOR OVERHEAD RAIN SHOWER  
BRAZO A PARED PARA ROCIADOR

**WJC205G0016001**  
CHROME / CROMO

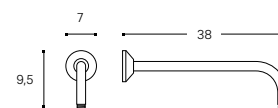

INCH 2.8x15x3.7

(2) Three functions: Massage, Rain, Soft.  
(2) Tres funciones: Massage, Rain, Soft.

(3) Includes: sliding bar, hand shower 12x12 cm.  
170 cm shower hose. Sliding hand shower holder.  
(3) Incluye: Barra de ducha. Ducha de mano de 12x12 cm.  
Flexo de 170 cm. Soporte deslizante.

(4) Includes: 22 cm shower head. Extensible sliding bar 30 cm. 170 cm shower hose.  
Hand shower ø10 cm. 1 function. Integrated hand shower holder.  
(4) Incluye: Rociador de 22 cm. Barra de ducha extensible 30 cm. Flexo de 170 cm.  
Ducha de mano de ø10 cm. 1 función. Soporte para ducha de mano integrado.



⊙  
 WALL ARM FOR OVERHEAD RAIN SHOWER  
 BRAZO A PARED PARA ROCIADOR

**WJC205G0023036**  
 MATT BLACK / NEGRO MATE

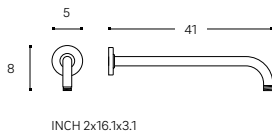

△  
 ROUNDED SHOWER HEAD 200 MM  
 ROCIADOR 200 MM

**WJC205G0026001**  
 CHROME / CROMO

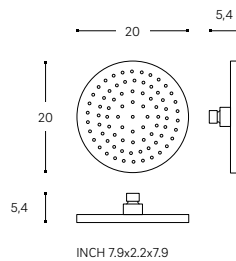

△  
 ROUNDED SHOWER HEAD 250 MM  
 ROCIADOR 250 MM

**WJC205G0022036**  
 MATT BLACK / NEGRO MATE

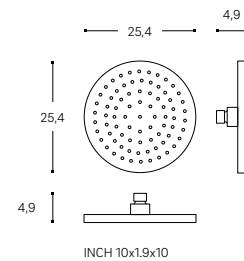

⊙  
 SHOWER ELBOW CONNECTION WITH HAND SHOWER HOLDER  
 TOMA DE AGUA CON SOPORTE

**WJC205G0024001**  
 CROMO / CHROM  
**WJC205G0024036**  
 MATT BLACK / NEGRO MATE

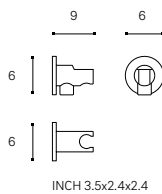

○  
 FLEXIBLE SHOWER HOSE  
 FLEJO

Ⓢ **WJC205G0021001**  
 CHROME / CROMO

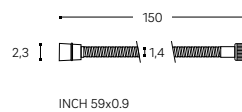

Ⓢ  
 FLEXIBLE SHOWER HOSE  
 FLEJO

Ⓢ **WJC205G0021036**  
 MATT BLACK / NEGRO MATE

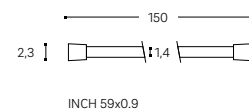



⊙  
WASTE VALVE CLICK-CLACK\*  
VÁLVULA DE DESAGÜE CLICK-CLACK\*

- S **WJC205G0018001**  
CHROME / CROMO
- S **WJC205G0018036**  
MATT BLACK / NEGRO MATE

\* For washbasins with overflow  
\* Para lavabos con rebosadero

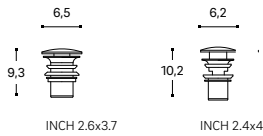

**We recommend Logic and Architect S+ accessories**  
Recomendamos accesorios Logic y Architect S+



# Spare parts

## Recambios



[https://www.icosmic.com/tarifas/recambios/  
BR\\_RECANVIS\\_EXP%20EN-ES%20SP%2023.pdf](https://www.icosmic.com/tarifas/recambios/BR_RECANVIS_EXP%20EN-ES%20SP%2023.pdf)





# Materials



## **FLOAT GLASS (Flat shelves and washbasin tops)**

Made using standard FLOAT type glass that has undergone no subsequent treatment other than the necessary machining, cutting and polishing. Therefore, it is a naturally fragile material and despite the fact that the most appropriate density has been used in every case, special care should be taken when using it. 100% recyclable.



## **PRESSED GLASS**

### **(Most of the glasses and soap dishes in our collection)**

A very similar material to the FLOAT glass used for the shelves, glasses, and soap dishes, etc. This molten glass is shaped in a mould. These products should be used and cared for in the same way as the shelves and washbasin tops. 100% recyclable.



## **TEMPERED GLASS**

This material is manufactured similarly to FLOAT glass, but also undergoes a thermal processing to increase its resistance. 100% recyclable.



## **MIRRORS**

Sheet of glass covered by layers of silver, copper and, finally, paint. The use of topquality raw materials in conjunction with the correct mirror manufacturing process guarantee maximum protection against stains caused by corrosion.



## **SYNTHETIC RESIN**

Is a technologically advanced and unique compound, made up of high percentage of mineral extenders from nature (ATH derived from bauxite) as well as a small one of high-pureness polyester and acrylic polymers; therefore, it is an inert, hypoallergenic and non-toxic material. 100% recyclable, practically fireproof (class 1), strongly UV-resistant, solid and nonporous, hygienic and healthy, resistant and agreeable to the touch for its velvety and natural.



## **CRISTALPLANT BIOBASED®**

Material made up of 50% natural minerals (aluminium trihydrate -ATH- derived from bauxite) and 50% high-purity polyester bioresins. Plant resins: this is the first ecologically sustainable solid surface, consisting of resins of plant origin and extremely pure natural minerals. It is an inert, hypoallergenic, non-toxic material. It is practically inflammable, certified Class 1 fire resistance. It is highly resistant to ultraviolet rays. It regains its original appearance with just soapy water and a scrubber.



## **PHENOLIC RESIN**

This material is a high pressure laminate (HPL) with a decorative surface. Typically the superficial layer consists of thermo-hardened resin-treated plywood. The special texture and durability of this material makes it very resistant to impact and scratching, and it is completely waterproof. Specially designed for use in places where hygiene is of the utmost importance, this material can be cleaned frequently with active detergents, chemical agents, or organic solvents.



## **VENEERED WOOD**

MDF boards + oak veneer varnished with fine quality materials to prevent yellowing. Oak wood is a material that is very resistant to biological agents (fungus and insects). As this kind of material is natural wood, it may present knots and color variation.



## **LACQUERED WOOD**

This material is made from double-faced MDF plywood. Its high quality varnish provides a bright or matte finish and prevents yellowing. Due to its delicate lacquered surface, we recommend the use of mild cleaning products, avoiding solvents or any abrasive substances.



## **PVC**

Polyvinyl chloride (PVC) is a polyvinyl chloride polymer used to manufacture numerous products and is also applied in making boards, panels, windows, shutters, etc. Its durability, colour stability, watertightness and moisture proof properties make PVC an ideal material for bathroom and kitchen furniture. The material can be cleaned quickly and easily with just soap and water, although its resilience means most cleaning products can also be used.



## **PLASTIC**

We use various technical plastics with different features to meet the manufacturing and aesthetic needs of each product. These include ABS (with or without chrome), PP, PA, PE, PC, PS, etc.



## **RECYCLED PLASTIC**

The material is a formulation comprised of 60% post-consumption waste from the inside of fridges, 30% remains generated from manufacturing yoghurt packaging, and 10% rice husks to give the product the resistance and appearance required for this form of use. These values are approximate and may vary depending on the starting point, since recycled materials' properties always fluctuate.



## **ACRYLIC GLASS**

The polymethylmetacrylate (PMMA) is known as one of the "engineering plastics", and is obtained through the polymerisation of methyl methacrylate. It stands out from other plastics due to the fact that it is impact resistant, weather resistant—as it does not undergo any significant ageing in ten years of outdoor exposure—resistant to UVA rays and scratch resistant. Due to its absolute transparency (it is the most transparent plastic), it is most commonly used in vehicle headlights, optics, medicine or partition panels. For use in architecture and decoration, it is lighter than glass and provides greater resistance to impact, meaning it can be a good substitute in many situations.



## **STAINLESS STEEL**

It is an alloy of iron and carbon. Steel maintains the iron hardness characteristics. This steel has a special chrome treatment against the rust and oxidation. The used alloys are SS201 & SS304.



## **BRASS OR SIMILAR ALLOYS (glossy chrome and matt chrome)**

A copper and zinc alloy—this is one of the non-ferrous metals, the proportion of which varies according to its use. It offers greater malleability than both copper and zinc separately, and it is easily refined which allows for a high level of design customization.







**ALUMINUM**

Aluminium alloy. May be presented as solid, extruded and calibrated. Aluminium is an important metal for numerous industries, such as the automotive industry where it is most common. It is generally a soft metal with low melting points.



**GLASS-LINED STEEL (VIT-TECH)**

Cutting-edge, 100% recyclable, non-porous and hygienic material made of fired pre-enamelled sheet steel. The vitreous enamel withstands corrosion, high temperatures and chemical agents. This durability means it can be used for a wide range of functional applications in bathtubs, shower trays and washbasins, as well as for ovens and coatings. It is an easy to clean material that does not require special cleaning products.



**TECKSTONE**

Advanced formula composed by natural minerals (calcium carbonate and quartz) mixed with resin. The surface is covered by GELMAT Premium Maxguard™ film, with plastic fibre and polymer, which provides the needed durability and resistance for an intensive daily use. It is a solid surface with excellent physic-mechanical properties that supplies important design possibilities. Its capacity of moulding allows reproducing forms with a great precision and with less curvature radius. Teckstone is very hard, resistant and compact; being a non porous material and without angles, it is very easy to maintain, the stains can be eliminated without effort and it is easy to clean.



**MARBLE**

**Carrara Marble.** Extracted from Italy's Tuscan quarries, each piece of marble is different and each stone has its own unique characteristics. Its white background has distinctive light blue-grey veins running through its surface.

**Marquina Marble.** Elegant and classic, each piece of marble is different and every stone has its own characteristics. Extracted from the quarries sited in Marquina (Vizcaya), it is characterized by its white veins on the black stone. The less veins it has, more appreciated is.

**Brescia Marble.** (Brown matt and glossy) from the region of Lombardy (Italy). It is considered as one of the most sumptuous Italian marble.



**PORCELAIN**

Ceramic product obtained from a sophisticated paste made up of kaolin, feldspar and quartz. Porcelain is treated with a vitrified top finish for surface hardness, colour and sheen. It is non-porous and hygienic, which makes it suitable for use in the bathroom. The vitrified finish means that it can be cleaned with any bathroom-specific product.



**VITREOUS CHINA**

The washbasin is made in a traditional way, it is characterized by high durability, resistance to abrasion and chemical agents.



**FÉNIX®**

Soft touch material and high performance: micro-scratch thermal reparability, anti-fingerprint, scratch resistance, high resistance to solvents and low light reflectivity. FENIX® products are made of paper (more than 60%) and thermosetting resins (30-40%). They are created through a pressure process in which heat and pressure are applied simultaneously to obtain a homogeneous non-porous product. The core structure is made of paper, impregnated with thermosetting resins. The outer surface is treated with the latest generation acrylic resins, hardened and set using the Electron Beam Curing process. It does not require any special maintenance, just a damp cloth with warm water or mild detergents. To remove the most common stains the surface can be cleaned with just warm water and a non-abrasive cloth. If the residue is old or has hardened, use a magic eraser sponge or a soft cloth to remove it. Always rinse thoroughly to remove detergent with clean, preferably warm water. Tests have shown that the removal of superficial micro-scratches using a "magic sponge" takes place both immediately and after 24 hours.



**SOLIDMAT**

A solid surface with a high percentage of natural mineral deposits. It stands out for its glossy feel and its durability. It is a fireproof material, compact and non-porous and both hygienic and resistant. Available in solid matt white.



**GELMAT**

Gel coat with chalk-paint texture and super-matte effect. This is an innovative manufacturing technique that consists of a resin and mineral load compound enriched with an outer gel coat layer. This outer coating grants it a chalk-paint texture and super-matte effect, as well as added durability and resistance. What makes this process innovative is the way the mould is made to obtain a smooth texture free from imperfections.

**CLEANING INSTRUCTIONS**

Clean with a liquid domestic cleaner or with soap suds. Afterwards rinse with clear water and polish with a cloth. Do not use any cleaning agents containing acid or scouring agents. Damage caused by improper treatment is not subject to our guarantee.



# Materiales



## VIDRIO FLOAT (Estantes y encimeras)

Realizado con vidrio tipo FLOAT estándar sin ningún otro tratamiento posterior más que la mecanización, corte y pulido necesarios. Se trata, pues, de un material que por su propia naturaleza es frágil y a pesar de que en cada caso se ha utilizado el espesor más adecuado, debe tenerse un especial cuidado en su uso. 100% reciclable.



## VIDRIO PRENSADO (Vasos y jaboneras de la mayoría de nuestras series)

Material muy similar al vidrio FLOAT utilizado en estantes, vasos, jaboneras... Este vidrio fundido es conformado en un molde. El uso y cuidados deben ser los mismos que para estantes y encimeras. 100% reciclable.



## VIDRIO TEMPLADO

Vidrio FLOAT sometido a tratamiento térmico para aumentar su resistencia. 100% reciclable.



## ESPEJOS

Plancha de vidrio sobre la que se aplica una capa de plata, cobre y finalmente pintura. El uso de materia prima de primera calidad, unido a un correcto proceso de fabricación de los espejos, aseguran la mayor protección contra las manchas por corrosión.



## RESINA SINTÉTICA

Es un material compuesto tecnológicamente avanzado y único, formado por un porcentaje elevado de minerales naturales (trihidrato de aluminio -ATH- derivado de la bauxita) y un bajo porcentaje de polímeros poliésteres y acrílicos de gran pureza; se trata, por lo tanto, de un material inerte, hipoalérgico y no tóxico. Es un material que puede reciclarse al 100%, prácticamente ignífugo (clase 1), con una óptima resistencia a los rayos ultravioletas; es compacto, no poroso, higiénico, resistente y agradable al tacto gracias a su acabado aterciopelado, similar al de la piedra natural.



## CRISTALPLANT BIOBASED®

Material compuesto formado por un 50% de minerales naturales (trihidrato de aluminio -ATH- derivado de la bauxita) y un 50% de biorresinas de poliéster de gran pureza. Es el primer solid surface eco sostenible que deriva de materias primas resinosas de origen vegetal, procedentes de cultivos certificados, mezcladas con minerales naturales de extrema pureza. Es un material inerte, hipoalérgico y no tóxico. Es prácticamente ignífugo, con certificado de resistencia al fuego Clase 1. Presenta una óptima resistencia a los rayos ultravioletas. Puede recuperar completamente su aspecto original utilizando simplemente agua jabonosa y estropajos abrasivos.



## RESINA FENÓLICA

La Resina Fenólica o Stratificato es un laminado de alta presión (HPL) con superficie decorativa. En general, la capa superficial está constituida por una superficie dura, basada en resinas de melamina, mientras que el grueso está constituido por un contrachapado impregnado de resina termo endurecida que le confiere al material una excepcional resistencia al impacto. Su especial textura y su durabilidad proporcionan una excelente resistencia al rayado. Gracias a su superficie perfectamente impermeable es un material resistente al desgaste, al agua y al vapor.



## MADERA CHAPADA

Tableros de DM + chapa de roble barnizado con materiales de primera calidad que evitan el amarillamiento. La madera de roble es un material muy resistente a los agentes biológicos (hongos e insectos), al ser una madera natural puede mostrar nudos y presentar variaciones de color entre piezas.



## MADERA LACADA

Tablero DM melaminado dos caras y lacado en acabados brillo y mate con barnices de primera calidad resistentes y que evitan el amarillamiento. Las superficies lacadas son delicadas y deben ser tratadas y limpiadas cuidadosamente, utilizando productos específicos para estas superficies. No usar nunca disolventes o productos abrasivos.



## PVC

El cloruro de polivinilo (PVC) es un polímero de cloruro de vinilo que se emplea para la fabricación de multitud de productos, encontrando aplicación en la realización de tableros, paneles, ventanas, persianas, etc. La larga durabilidad, estabilidad del color, estanqueidad al agua y resistencia a la humedad, son las características que hacen del PVC un material idóneo para muebles de baño y de cocina. La limpieza de este material es fácil y rápida y se realiza con agua y jabón, aunque por su resistencia permite el empleo la mayoría de productos de limpieza.



## PLÁSTICO

Cosmic utiliza plásticos técnicos de distintas características en función de las necesidades de fabricación y estéticas de cada producto o pieza. Entre los plásticos utilizados están: ABS (cromado o no), PP, PA, PE, PC, PS, etc.



## PLÁSTICO RECICLADO

El material es una formulación compuesta por un 60% residuos posconsumo procedente del interior de neveras, un 30% de restos de fabricación de envases de yogur y un 10% de cáscara de arroz que dota de la resistencia y el aspecto necesario para una aplicación como esta. Los valores son aproximados y pueden variar dependiendo de la partida ya que los materiales reciclados siempre presentan una oscilación de las propiedades.



## CRISTAL ACRÍLICO

El Polimetilmetacrilato (PMMA) es conocido como uno de los "plásticos de la ingeniería", se obtiene de la polimerización del metacrilato de metilo. Destaca frente a otros plásticos por la resistencia a los impactos, a la intemperie, ya que no sufre un envejecimiento apreciable en diez años de exposición exterior y a los rayos UVA, y por la resistencia al rayado. Por su transparencia máxima (es el plástico más transparente), las funciones más habituales van desde los faros de los vehículos, la óptica, la medicina o mamparas separadoras. Para su uso en la arquitectura y decoración se beneficia de un peso menor al del vidrio y mayor resistencia a impactos por lo cual puede ser un buen sustituto en muchas ocasiones.



## ACERO INOXIDABLE

Aleación de hierro con carbono que conserva las propiedades de dureza del hierro. Se trata de un acero con un tratamiento especial de cromo, contra la corrosión y oxidación. Las aleaciones utilizadas son la SS303 y SS304.





### **LATÓN O ALEACIONES ANÁLOGAS (cromo brillante y cromo mate)**

Aleación de cobre y zinc, es uno de los metales no férricos, cuya proporción varía en función de su aplicación. Destaca su maleabilidad, más alta que la del cobre y zinc por separado, y fácil pulido lo cual permite un alto grado de adaptación en el diseño de las piezas.



### **ALUMINIO**

Aleación de aluminio. Se puede presentar como macizo extrusionado, estirado y calibrado. El aluminio es un metal importante para una gran cantidad de industrias, como la del automóvil, donde se utiliza habitualmente. Tiende a ser blando y presenta puntos de fusión bajos.



### **ACERO VITRIFICADO (VIT-TECH)**

Material tecnológicamente avanzado y 100% reciclable que nace de la cocción de una superficie de acero esmaltada previamente. Es un material no poroso, higiénico y resistente a la corrosión, a las altas temperaturas y a agentes químicos debido a la naturaleza vítrea del esmalte. Esta característica le confiere una gran dureza permitiendo una amplia gama de aplicaciones en bañeras, platos de ducha y lavabos así como hornos y revestimientos. Es un material de fácil limpieza que no requiere la utilización de productos de limpieza específicos.



### **TECKSTONE**

Formulación avanzada compuesta de minerales naturales (carbonato de calcio y cuarzo) mezclados con resina. La película GELMAT Premium Maxguard™, con fibras de plástico y polímeros, recubre la superficie proporcionando la durabilidad y resistencia que necesita el uso diario intensivo. Se trata de una superficie sólida con excelentes propiedades físico-mecánicas que ofrece grandes posibilidades de diseño. Su capacidad de moldeo permite reproducir formas con gran precisión y con menores radios de curvatura. Teckstone es muy resistente, compacto y de gran dureza. Al ser un material no poroso y carente de juntas, su mantenimiento es muy sencillo, las manchas se eliminan sin esfuerzo y es de fácil limpieza.



### **MÁRMOL**

**Mármol Carrara** (Blanco mate y brillo). Extraído de las canteras de la Toscana italiana, cada pieza de mármol es diferente y cada piedra tiene sus propias características. Con fondo blanco tiene distintivas vetas de color azul grisáceo claro repartidas por toda la superficie.

**Mármol Marquina** (negro mate y brillo). Elegante y clásico, cada pieza de mármol es diferente y cada piedra tiene sus propias características. Se extrae de las canteras en Marquina (Vizcaya) y se caracteriza por sus vetas de color blanco sobre la piedra negra. Cuantas menos vetas, más apreciado.

**Mármol Brescia** (marrón mate y brillo). Extraído de las canteras de la región de Lombardia (Italia). Considerado uno de los mármoles italianos más suntuosos.



### **PORCELANA**

Producto cerámico que se obtiene a partir de una pasta muy elaborada compuesta por caolín, feldespato y cuarzo. La porcelana es tratada con un acabado final vitrificado que da a la superficie la dureza superficial, color, brillo, no porosidad e higiene idóneos para su uso en el baño. Este vitrificado permite limpiarla con cualquier producto destinado a la limpieza del baño.



### **CERÁMICA**

El lavabo está hecho de forma tradicional, se caracteriza por una alta durabilidad, resistencia a la abrasión y agentes químicos.



### **FÉNIX®**

Material suave al tacto de elevadas prestaciones: reparabilidad térmica de micro-arañazos, anti-huella digital, resistencia a los arañazos, alta resistencia a los disolventes y reflectancia mínima a la luz. Los productos de FENIX® están realizados de papel (más del 60 %) y de resinas termo endurecedoras (30-40 %). Están creados por un proceso de presión en el que el calor y la presión se aplican de manera simultánea para obtener un producto homogéneo no poroso. La estructura del núcleo está compuesta de papel, impregnado con resinas termo endurecedoras. La superficie exterior está tratada con resinas acrílicas de nueva generación, endurecidas y fijadas con el proceso Electron Beam Curing. No requiere ningún mantenimiento especial, solo un paño húmedo con agua templada o detergentes suaves. Para las manchas más comunes es suficiente con limpiar la superficie con agua templada usando un paño no abrasivo. Si los residuos son antiguos o se han endurecido, usar una esponja mágica o un paño suave para eliminarlos. Siempre enjuagar a fondo para eliminar el detergente con agua limpia, preferiblemente tibia. Las pruebas han demostrado que la eliminación de micro arañazos superficiales mediante "esponja mágica" tiene lugar tanto inmediatamente como después de 24 horas.



### **SOLIDMAT**

Un solid surface con un alto porcentaje de cargas minerales naturales. Destaca por su tacto satinado y su durabilidad. Es un material ignífugo, compacto y no poroso, higiénico y resistente. Disponible en blanco mate homogéneo.



### **GELMAT**

Gel coat con textura de pintura a la tiza efecto super mate. Una innovadora técnica de fabricación que consiste en un compuesto de resinas y cargas minerales, enriquecidos con una capa exterior de Gelcoat. Este recubrimiento exterior le confiere textura de pintura a la tiza efecto super mate, aportando un extra de dureza y resistencia. Lo innovador en este proceso consiste en la manera de fabricar el molde para obtener una textura lisa sin imperfecciones.

## **INSTRUCCIONES DE LIMPIEZA**

Las superficies pueden limpiarse con productos de limpieza líquidos o con agua jabonosa. (Tener en cuenta las instrucciones de uso del fabricante de detergentes). A continuación aclarar con abundante agua y pulir con una gamuza. No utilizar productos de limpieza que contengan ácidos, vinagre o que sean abrasivos. No nos responsabilizaremos si los desperfectos se producen a causa de un manejo inadecuado.



# Sales conditions

## EXPORT GENERAL SALES CONDITIONS

- 1**

The sales of INDUSTRIAS COSMIC S.A.U. are ruled by the herewith detailed general sales condition and the delivery of any order implies the buyer's acceptance of these general conditions.
- 2**

The products can be modified, replaced or cancelled at any time and all information of any kind included in our catalogues, price lists or advertising materials are indicative.
- 3**

Orders received from customers or through our salesmen are always subject to our previous approval and are considered confirmed unless otherwise specified.
- 4**

No order accepted by INDUSTRIAS COSMIC, S.A.U. can be amended or cancelled without our approval. The customer, as far as he is concerned, cannot return any goods to us without our previous acceptance or consent.
- 5**

Goods will be invoiced in accordance with our current price list at the moment of shipment. The prices are F.C.A. Barcelona for orders above € 1,500; for orders below € 1,500 goods will be shipped under Ex-Works conditions.
- 6**

Unless otherwise agreed, the payment terms are:  
-Irrevocable Letter of Credit at sight  
-Advanced Bank Transfer  
-Cash Against Documents
- 7**

INDUSTRIAS COSMIC, S.A.U. offers 3 years guarantee, in exception of the indicated in the price list, against raw material and manufacturing defects. The guarantee is valid from the time of purchase by the final customer. To confirm the date of purchase, the invoice of the consumer should be provided. The guarantee consists of the replacement of the defective piece that impedes the regular use of the item, except in case of improper use, incorrect assembly or installation, natural wear and tear, improper maintenance or, chemical, electrochemical or electrical influences. We are not responsible for all the damage brought about by misuse or bad installation of the products and won't accept any indemnities for the replacement of defective pieces or any demands for damage.
- 8**

INDUSTRIAS COSMIC, S.A.U. always try to minimize the customer service time and to meet the lead time requirements on our customers' orders as much as possible. In case we cannot satisfy them, customers will be duly advised.
- 9**

Ordered COSMIC products will be delivered under reservation of title in favour of INDUSTRIAS COSMIC, S.A.U. until all payment obligations by the purchaser have been met in full.
- 10**

In case of outstanding payments, the return and bank expenses are on the purchaser's. INDUSTRIAS COSMIC S.A.U. has the right to block all orders accepted as long as the outstanding payments are not sorted out.
- 11**

In case of claims regarding the interpretation or execution of the herewith sales conditions, will be competent the courts of our head office's jurisdiction.
- 12**

COSMIC provides information on the certifications with which we comply as a manufacturer. It is the responsibility of the fitter to know the local certifications required in the relevant country.



# Condiciones de venta

## CONDICIONES GENERALES DE VENTA EXPORTACIÓN

- 1**

Las ventas de INDUSTRIAS COSMIC, S.A.U. se realizan según las condiciones generales aquí expuestas y la entrega de cualquier pedido supone la aceptación, por parte del comprador, de dichas condiciones generales de venta.
- 2**

Los productos se pueden modificar, reemplazar o suprimir en todo momento y la información de cualquier naturaleza contenida en nuestros catálogos, tarifas o material publicitario es indicativa.
- 3**

Los pedidos recibidos directamente de los clientes o realizados por nuestros representantes en nombre de ellos siempre estarán sujetos a nuestra aceptación. INDUSTRIAS COSMIC, S.A.U. da por confirmados todos los pedidos recibidos y, si no hay notificación específica se entenderán como aceptados.
- 4**

Ningún pedido aceptado por nosotros se podrá retractar ni anular sin nuestra aceptación. El cliente, por su parte, no podrá efectuar ninguna devolución de mercancía sin nuestro consentimiento previo.
- 5**

La mercancía será facturada de acuerdo con nuestra tarifa vigente en el momento del envío. Los precios serán F.C.A. Barcelona para pedidos superiores a 1.500€. Los pedidos inferiores a 1.500€ serán enviados ExWorks.
- 6**

De no existir otro acuerdo, las condiciones de pago serán:  
-Letra de crédito irrevocable a la vista  
-Transferencia por avanzado  
-Contado contra documento
- 7**

INDUSTRIAS COSMIC, S.A.U. ofrece una garantía de 3 años, excepto en los casos indicados en la tarifa, contra todos los defectos de materia prima y fabricación válida a partir del momento de adquisición por parte del cliente final. A fin de determinar la fecha de adquisición será imprescindible la presentación de la factura de compra. Esta garantía consistirá en la sustitución de la pieza que determine su irregular funcionamiento, salvo por razones de uso inadecuado, montaje o instalación incorrectos, mantenimiento indebido, desgaste del uso diario o defectos provocados por reacciones químicas, electroquímicas o eléctricas. La garantía excluye de responsabilidad a INDUSTRIAS COSMIC, S.A.U. de todas las consecuencias derivadas del funcionamiento o instalación de nuestros productos y esta no reconoce ninguna indemnización por la sustitución de artículos defectuosos ni demanda por daños y perjuicios.
- 8**

INDUSTRIAS COSMIC, S.A.U. intenta siempre reducir al máximo los tiempos de servicio al cliente, ajustándose en lo posible a los requisitos de plazo solicitados expresamente en el pedido y, en caso de no poder satisfacerlos, se enviará una notificación.
- 9**

Los productos marca COSMIC, objeto de pedido, se entregarán bajo reserva de dominio a favor de INDUSTRIAS COSMIC, S.A.U. hasta el total cumplimiento de las obligaciones de pago por parte del comprador.
- 10**

En caso de impagos, se incurre en un cargo por devolución, más los gastos de financiación actuales en el mercado. INDUSTRIAS COSMIC, S.A.U. se reserva el derecho de retener los pedidos en curso hasta solucionar los efectos pendientes.
- 11**

Las disputas referentes a la interpretación o a la ejecución de estas condiciones generales de venta pasarán a ser competencia de los tribunales de nuestra jurisdicción.
- 12**

COSMIC aporta la Información de las certificaciones que cumplimos como fabricantes. Es responsabilidad de los instaladores conocer las certificaciones necesarias en cada país.

INDUSTRIAS COSMIC  
C/ESQUEIS S/N. LOCAL 1  
POL. IND. CAN BARRI  
08415 BIGUES I RIELLS  
BARCELONA SPAIN  
T. +34 938 654 277  
info@icosmic.com  
[www.icosmic.com](http://www.icosmic.com)

PRINTING DATE: MARCH 2023  
FECHA DE IMPRESIÓN: MARZO 2023





**ART DIRECTION**  
COSMIC STUDIO

**GRAPHIC DESIGN**  
AT COMUNICACIÓ

# COSMIC

**INDUSTRIAS COSMIC, S.A.U.**

C/ESQUEIS S/N LOCAL 1  
POL. IND. CAN BARRI  
08415 BIGUES I RIELLS BARCELONA SPAIN

**CENTRAL OFFICE** TEL +34 938 654 277

**INTERNATIONAL PHONE** TEL +34 938 664 101

**SHOWROOM** C/ESQUEIS S/N LOCAL 1 POL. IND. CAN BARRI  
08415 BIGUES I RIELLS BARCELONA SPAIN

info@icosmic.com  
[icosmic.com](http://icosmic.com)



[icosmicbath](https://www.instagram.com/icosmicbath)



2023 EN ES

